

G-21/10/2019

**Gabarito**  
**Especificações**  
**técnicas**  
**PORTA 10 mm**



*Slide*  
**DOOR**<sup>®</sup>  
LEAVES

 Reflexo de tecnologia,  
qualidade e conforto.



# Especificação Técnica

Slide Door Leaves 10 mm.

- Largura máxima por folha 1400mm, altura máxima por folha 3500mm
- Peso máximo 160kg por folha.
- Obs: Se a folha ultrapassar a largura de 1400 mm, adicionar mais uma roldana.

Slide Door Light 8 mm.

- Largura máxima por folha 1300mm, altura máxima por folha 2200mm
- Peso máximo 130kg por folha.
- Obs: Se a folha ultrapassar a largura de 1300 mm, adicionar mais uma roldana.

Slide Door Windows 8 e 6 mm.

- Largura máxima por folha 1000mm, altura máxima por folha 1800mm
- Peso máximo 75 kg por folha.
- Obs: Se a folha ultrapassar a largura de 1000 mm, adicionar mais uma roldana.

Garantia da Roldana é de 1 (um) ano por defeito de fabricação





Visite nosso site e utilize nosso aplicativo,  
é gratis,simples e fácil.

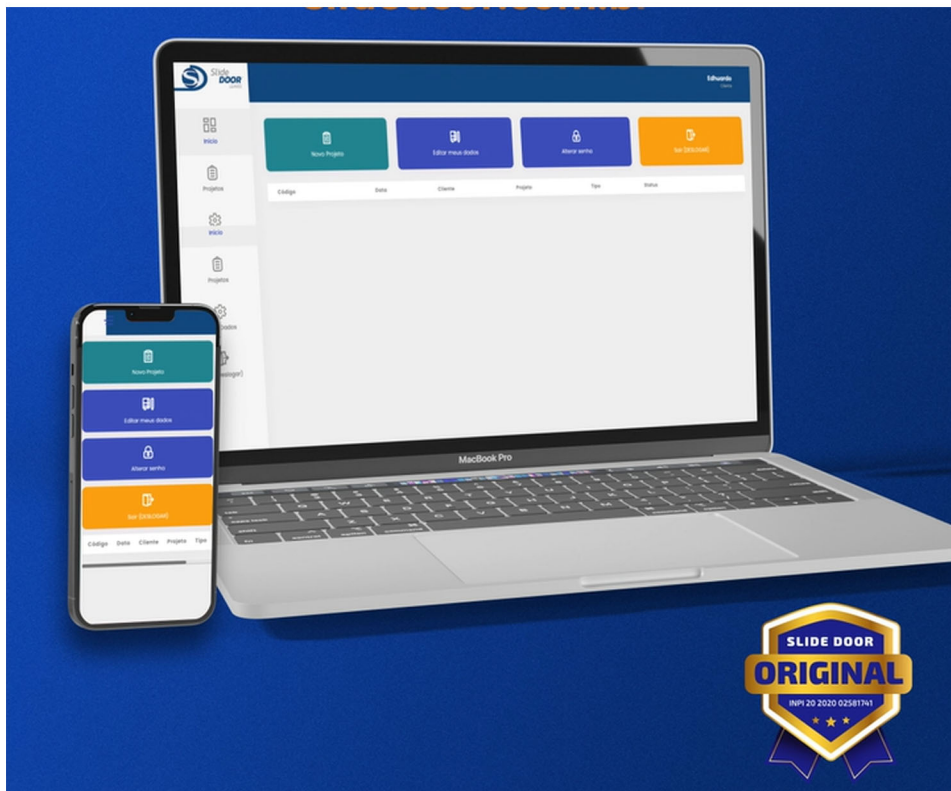

Em poucos segundos vc terá o projeto dos vidros,  
com recorte e furações.

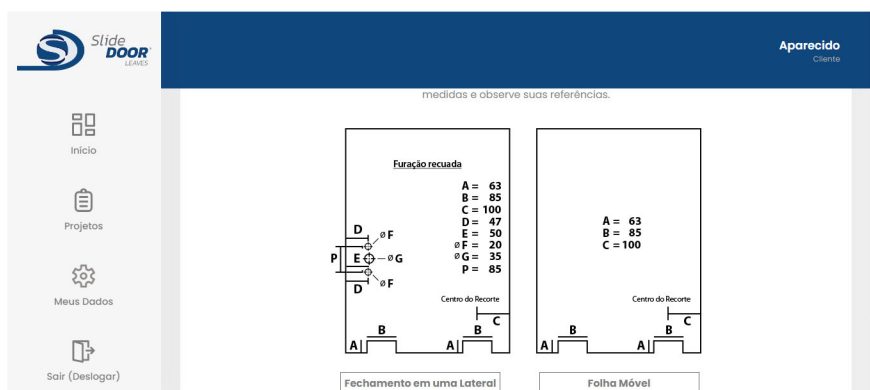



Slide  
**DOOR**<sup>®</sup>  
LEAVES

# TRILHO INFERIOR

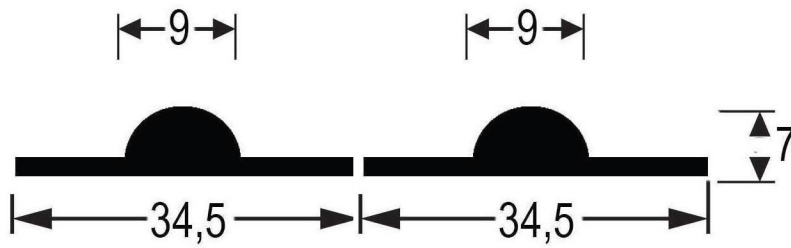
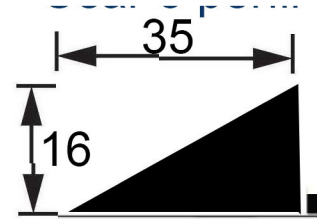
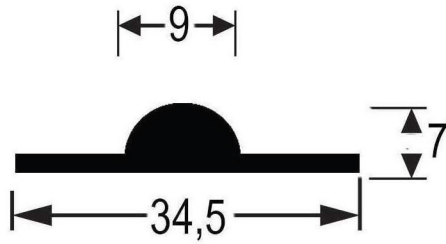

69

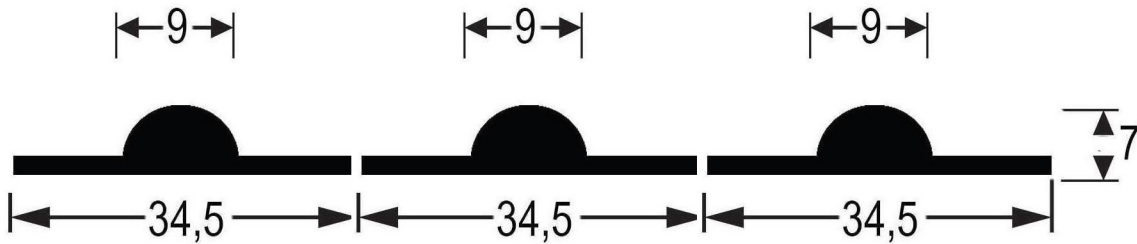

103,5





## Interna

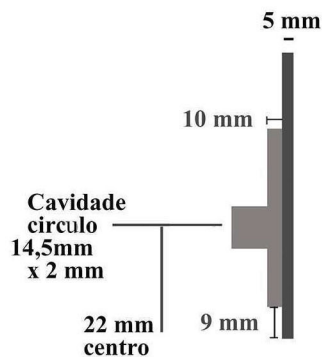

## Externa

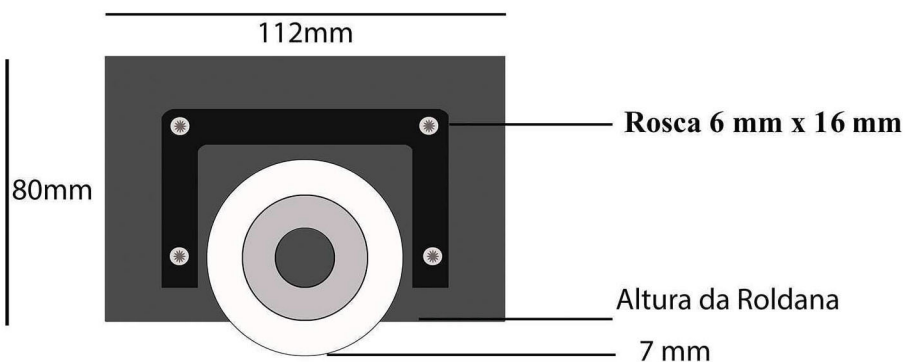

Paginar a roldana na borda do vidro

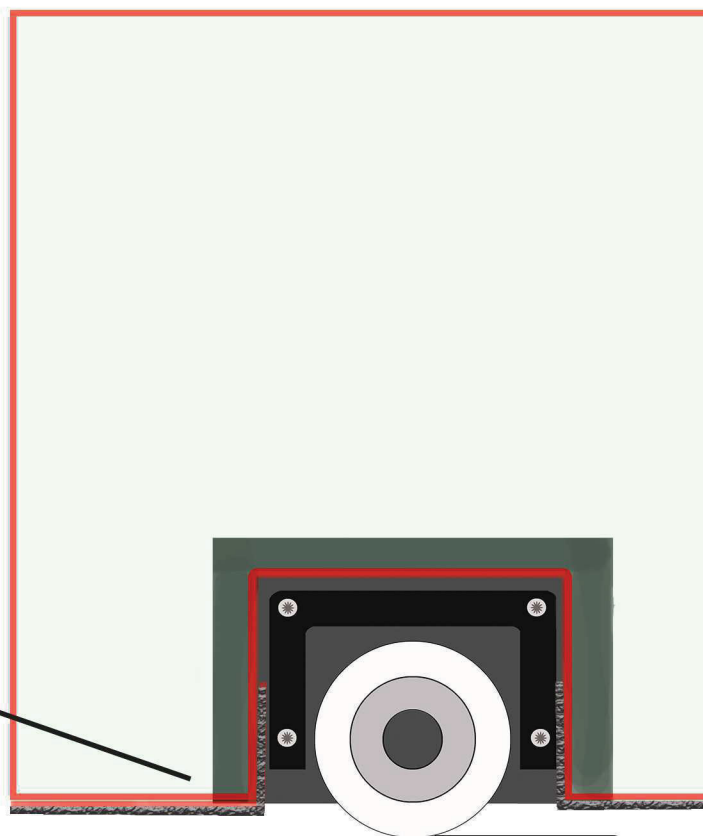

Colar escovinha na borda inferior do vidro

15mm 20 mm

Perfil lateral  
Altura 20mm  
Largura 15mm

## EXCLUSIVA CONTRA FECHADURA



130mm

20 mm

## EXCLUSIVO PERFIL LATERAL





# TRANSPASSE

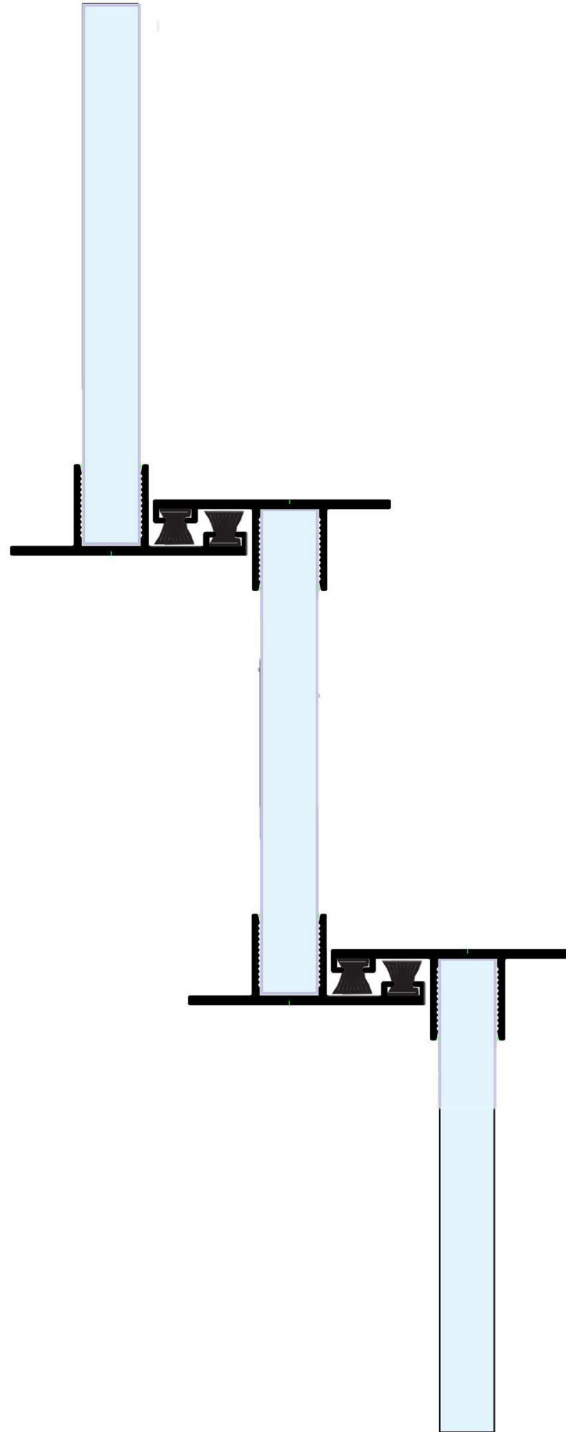
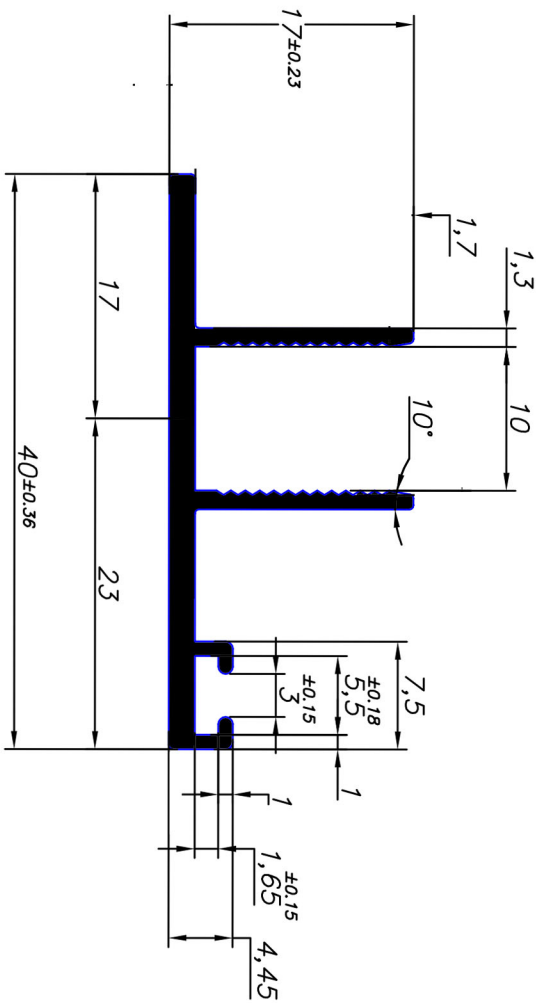

# TRILHO SUPERIOR

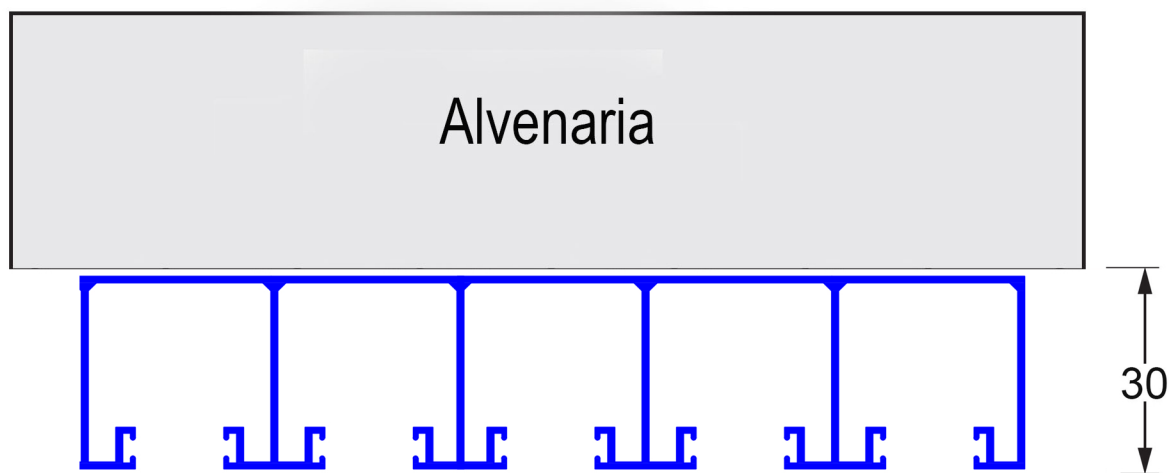
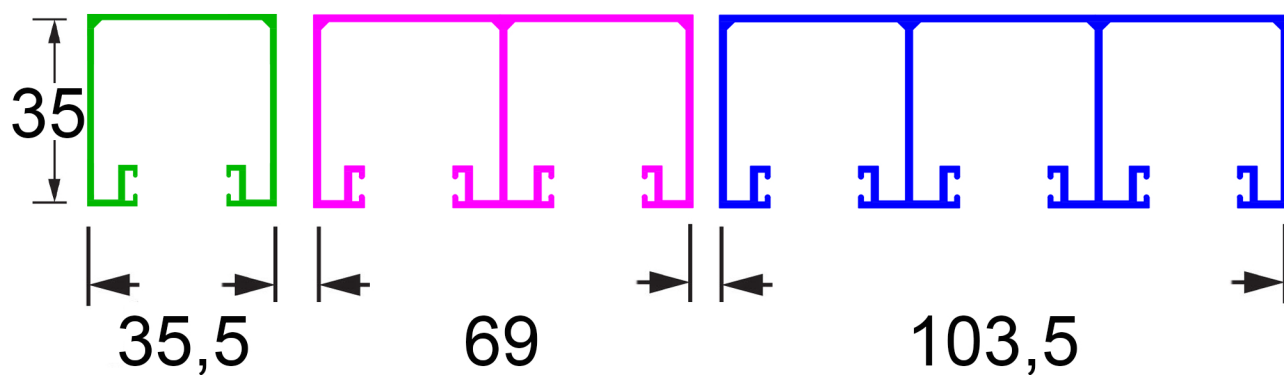



# GABARITO

Recorte em mm  
Folhas centrais de correr

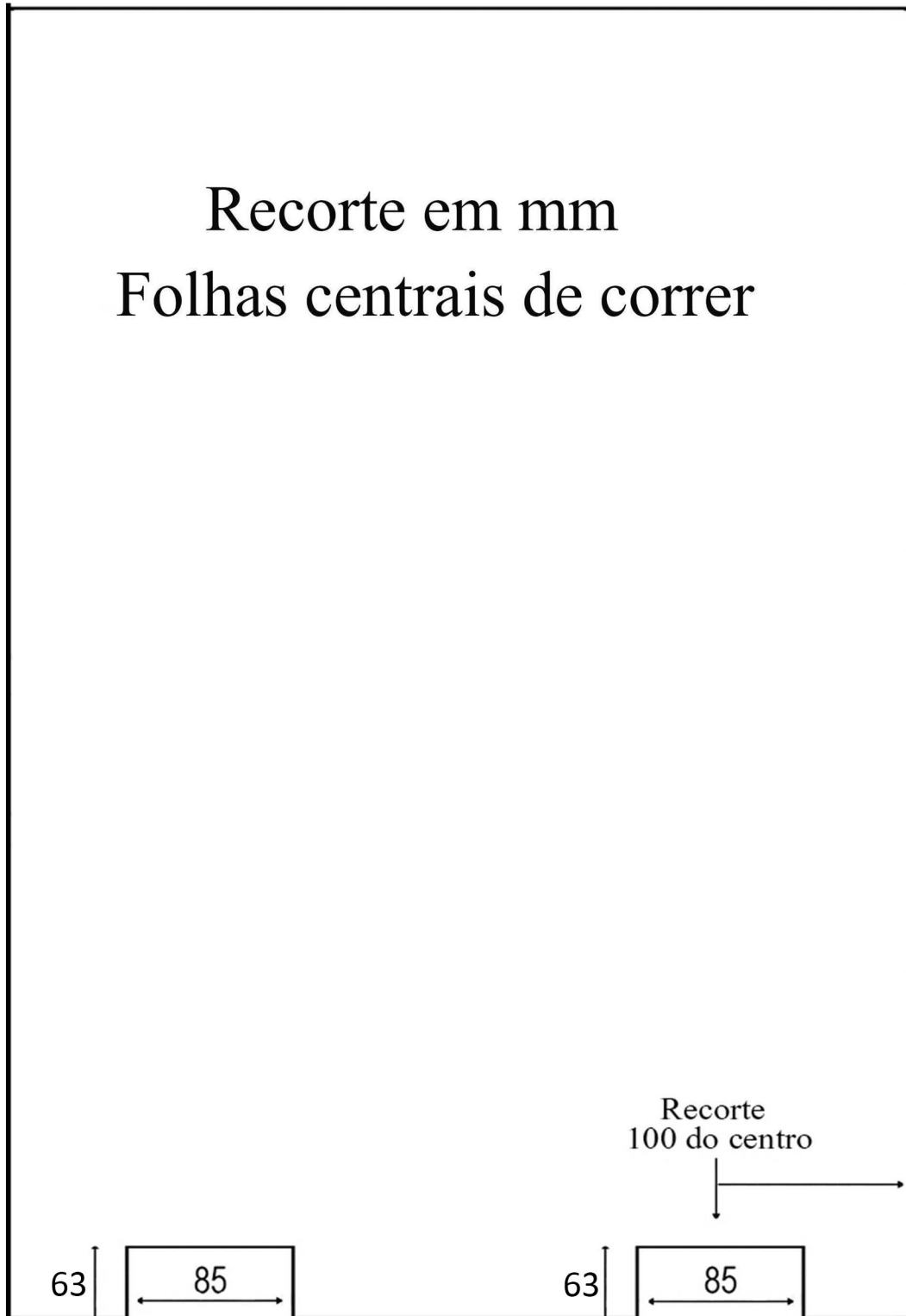







Slide  
**DOOR**<sup>®</sup>  
LEAVES

# GABARITO

Folha(s) Móveis com  
Fechadura central v/v

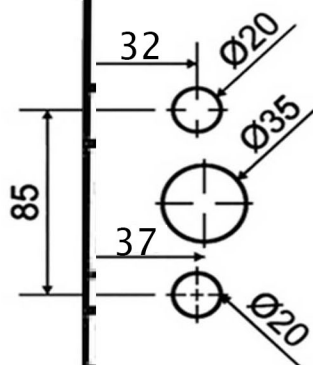

Centro do Recorte

100

63

85

63

85



# DIVISÃO DE VIDROS ABERTURA V/A

Altura, do vão descontar 30 mm  
nas folhas moveis

Altura, do vão descontar 20mm  
na folha fixa

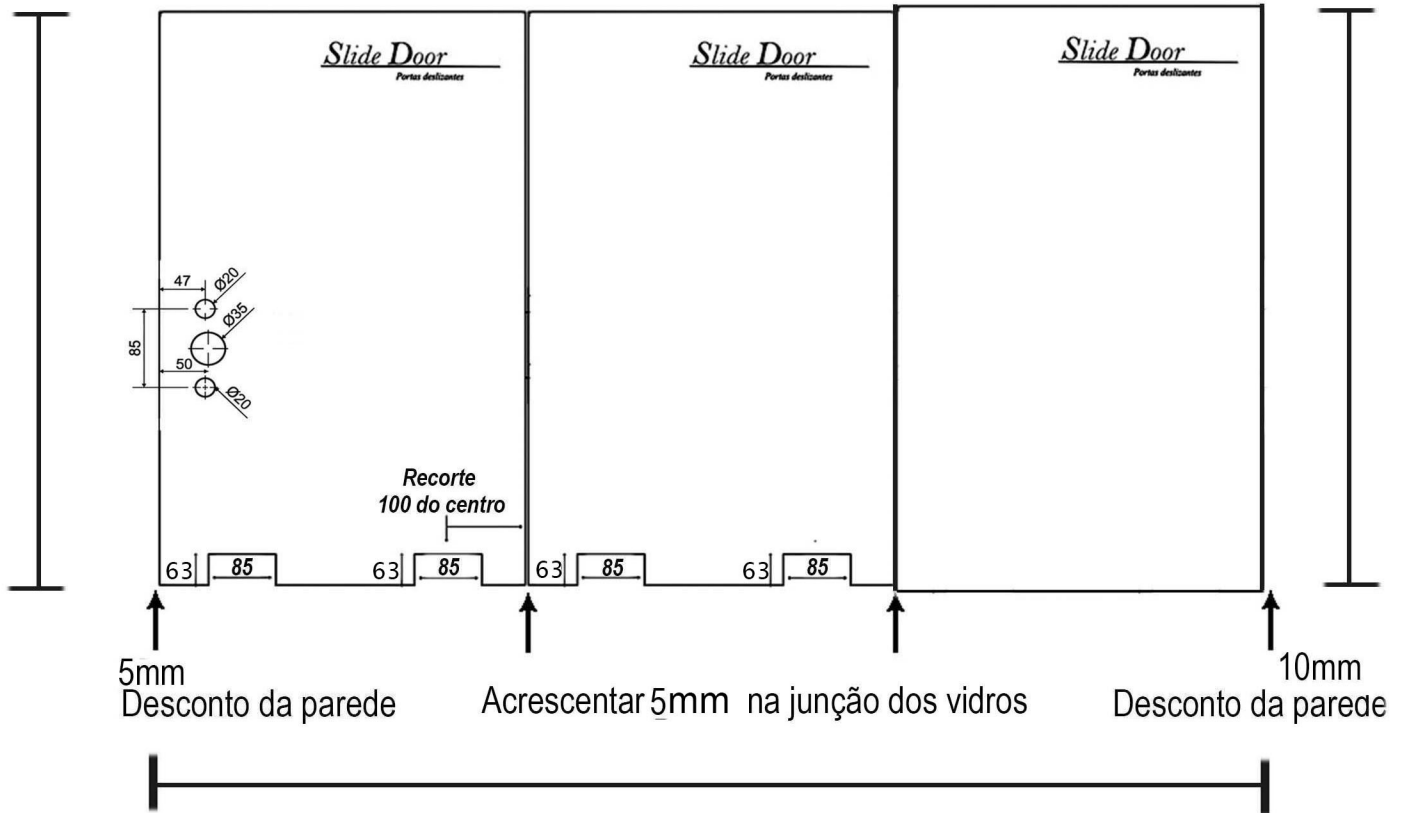

Largura do vão:

- 1- Descontar 5 mm do lado da fechadura e 10mm do lado do fixo
- 2- Acrescentar 5 mm cada junção de vidro
- 3- No resultado da medida, diminuir 100 mm se for só com fechadura ou 160 mm caso tenha puxador
- 4- Dividir o resultado no total de número de folhas, esta será a medida de cada largura das folhas, sem fechadura e fixos.
- 5- Acrescentar em cada folha móvel com fechadura 100 mm ou 160 mm se for com puxador, esta será a medida da folha móvel com fechadura ou com puxador.

Esta operação é para que a fechadura ou o puxador não bata no transpasse na hora da abertura

Altura do vão:

Descontar 20mm no fixo e 30 mm nos móveis .



# DIVISÃO DE VIDROS ABERTURA V/V

Altura, do vão descontar 30 mm

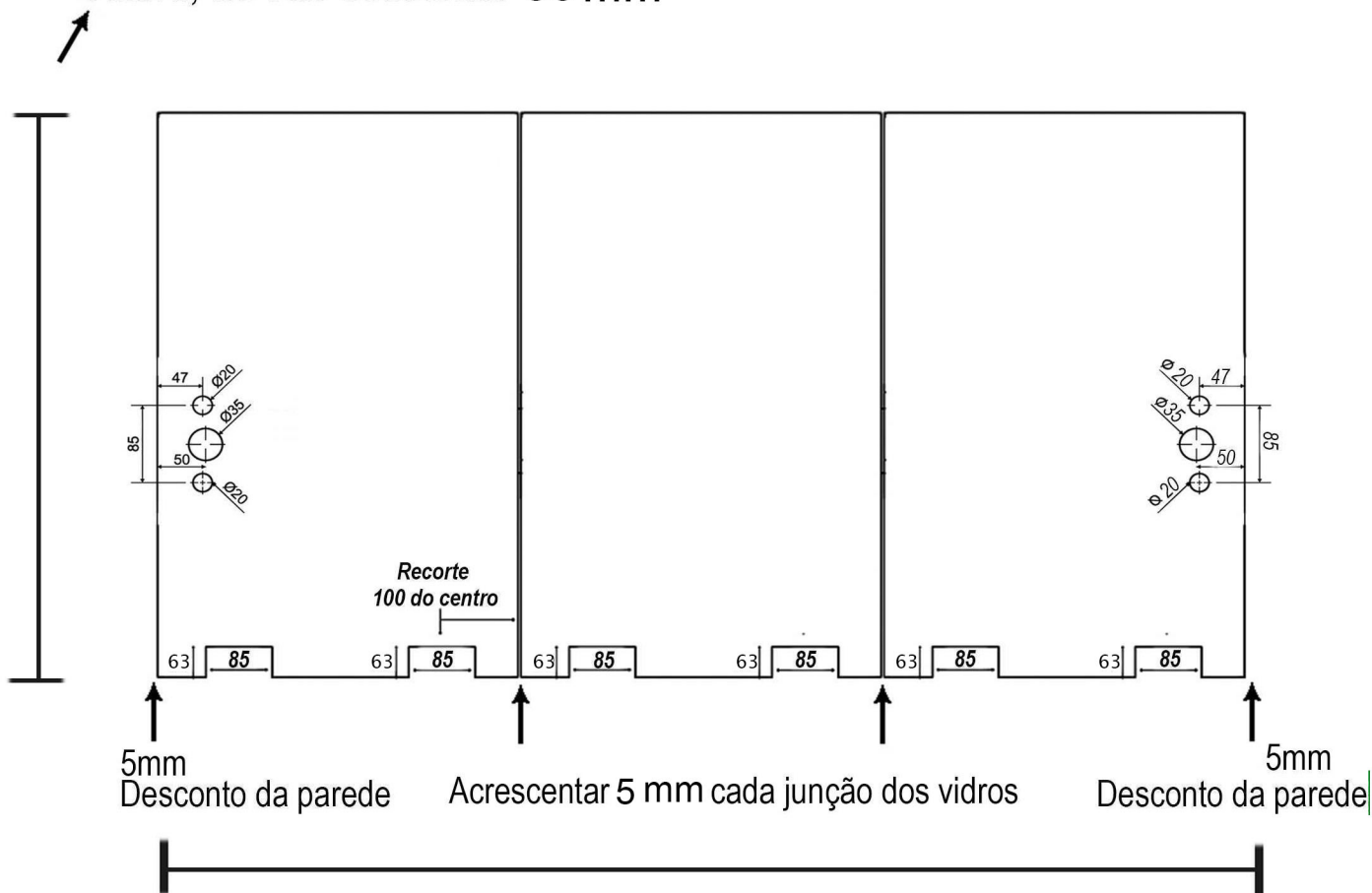

Largura do vão:

- 1- Descontar 5 mm de cada lado da fechadura
- 2- Acrescentar 5 mm cada junção de vidro
- 3- No resultado da medida, diminuir 200 mm se for só com fechadura ou 320 mm caso tenha puxador
- 4- Dividir o resultado no total de número de folhas, esta será a medida de cada largura das folhas, sem fechadura.
- 5- Acrescentar em cada folha móvel com fechadura 100 mm ou 160 mm se for com puxador, esta será a medida da folha móvel com fechadura ou com puxador.

Esta operação é para que a fechadura ou o puxador não bata no transpasse na hora da abertura.

Altura do vão:

Descontar 30 mm nas moveis



# DIVISÃO DE VIDROS ABERTURA V/V

Altura, do vão descontar 30 mm

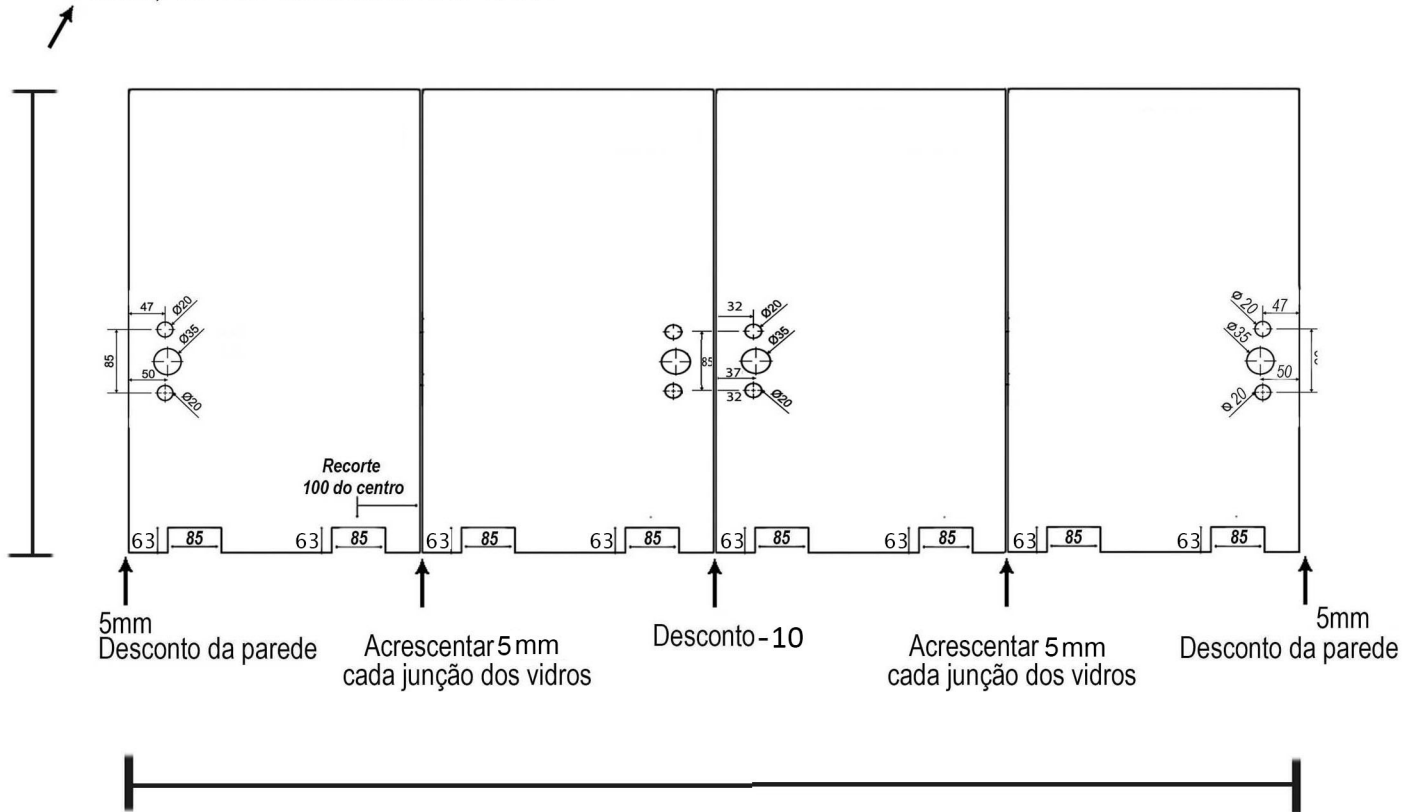

Largura do vão:

- 1- Descontar 5 mm de cada lado da fechadura e 10 mm na junção do vidro do centro
- 2- Acrescentar 5mm cada junção de vidro menos a do centro
- 3- No resultado da medida, diminuir 400 mm se for só com fechadura ou 640 mm caso tenha puxador
- 4- Dividir o resultado no total de número de folhas, esta será a medida de cada largura as folhas, sem fechadura.
- 5- Acrescentar em cada folha móvel com fechadura 100 mm ou 160 mm se for com puxador, esta será a medida da folha móvel com fechadura ou com puxador.

Esta operação é para que a fechadura ou o puxador não bata no transpasse na hora da abertura.

Altura do vão:  
Descontar 30 mm





# INSTALAÇÃO PASSO A PASSO

Pegar a menor medida do vão dentro do esquadro,  
conforme a figura 1 e 2

## 1- Medir a menor altura do vão

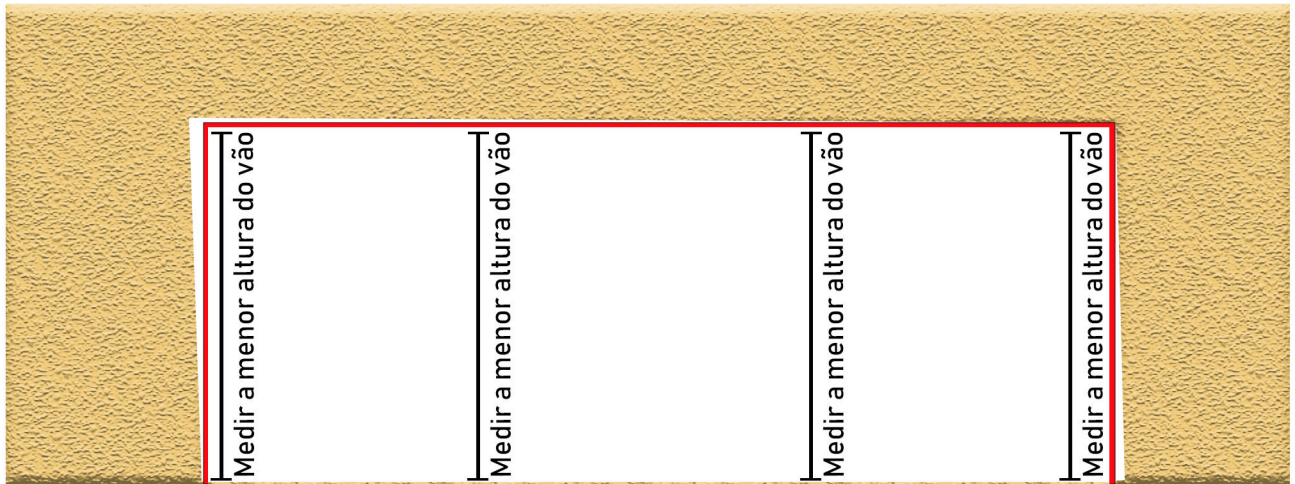

Prumo do Vão

## 2- Medir a menor largura do vão

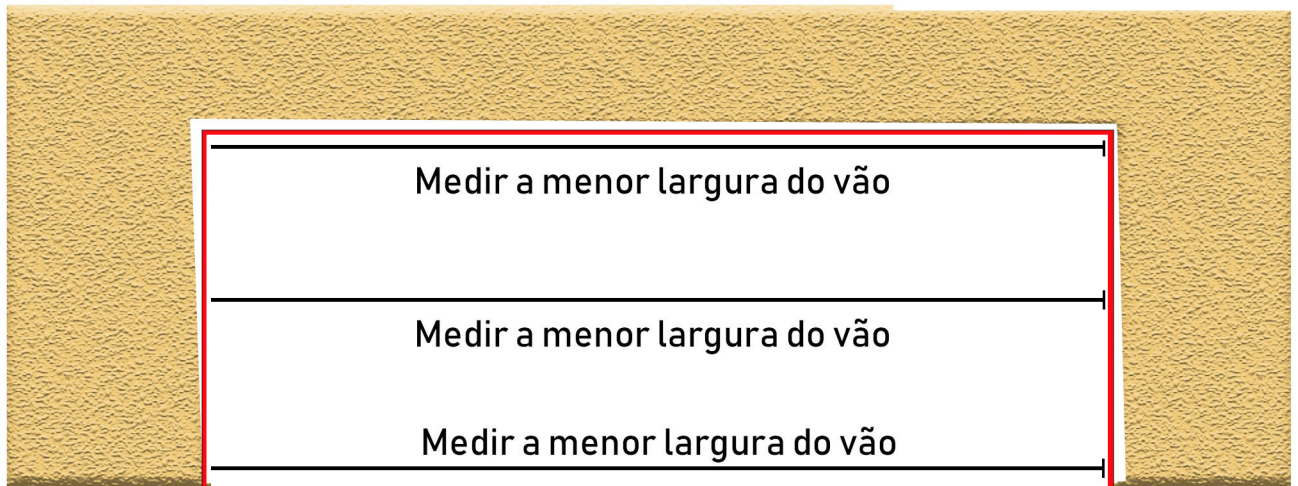

Prumo do Vão

Praticar a menor medida dentro do esquadro



# PRUMO DOS TRILHOS

Antes de iniciar a instalação, confira se as medidas de altura estão de acordo com o projeto.

Medir a soleira e a viga superior, verificando se o espaço é suficiente para a instalação.

Instale o trilho superior no prumo (Figura 1)

Se existir um desalinhamento entre a parte superior a inferior, figura (2,3,4), a instalação deverá ser ajustada com o auxílio de cantoneiras, tubos ou chapas.

Figura 1



Figura 2



Figura 3

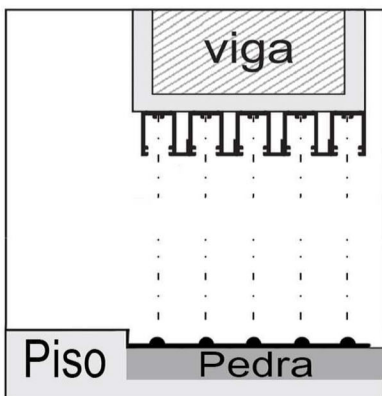

Figura 4

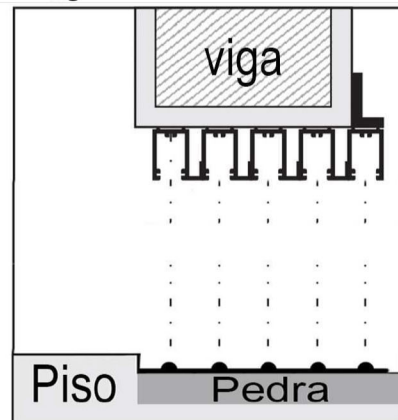

4- Aplique silicone PU 40 na parte inferior do trilho  
Somente cole o trilho lado a lado no piso e no promo  
do trilho superior

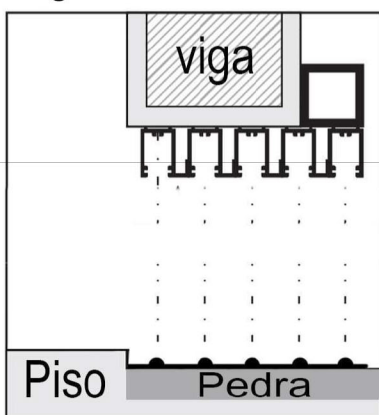
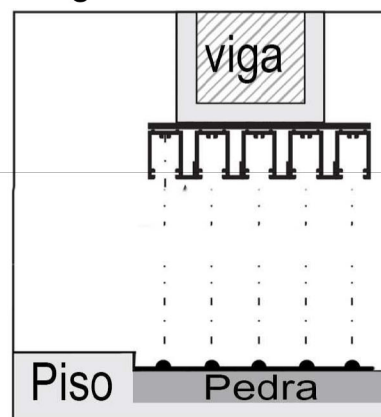

20 mm  
Interno

Externo

Segunda opção, quando a porta externa estiver ao mesmo nível:  
Usar o perfil de estancamento de água.

(Perfil vendido separadamente do kit)

Externo

Externo

Porta interna, colar o trilho inferior lado a lado

Interno

Interno



7- Colar os trilhos um de cada vez, um ao lado do outro, encostando as laterais e unindo para ficar uniforme, conforme as fotos ilustrativas.

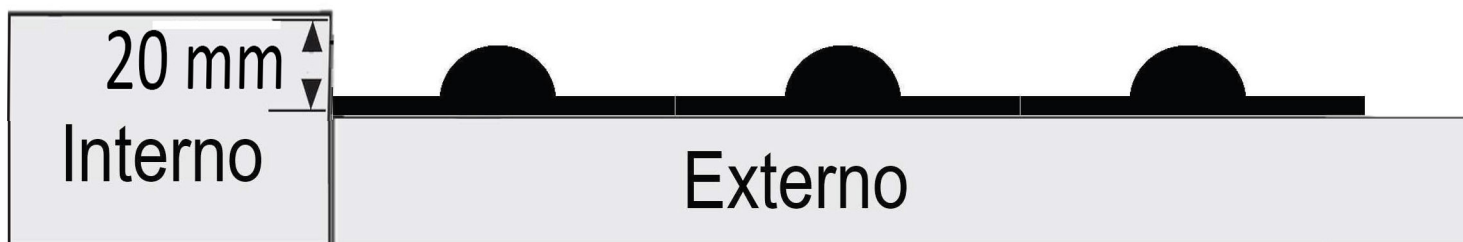

Obs.

Se o piso estiver no mesmo nível, instale o trilho de estancamento de água

(Perfil vendido separadamente do kit)

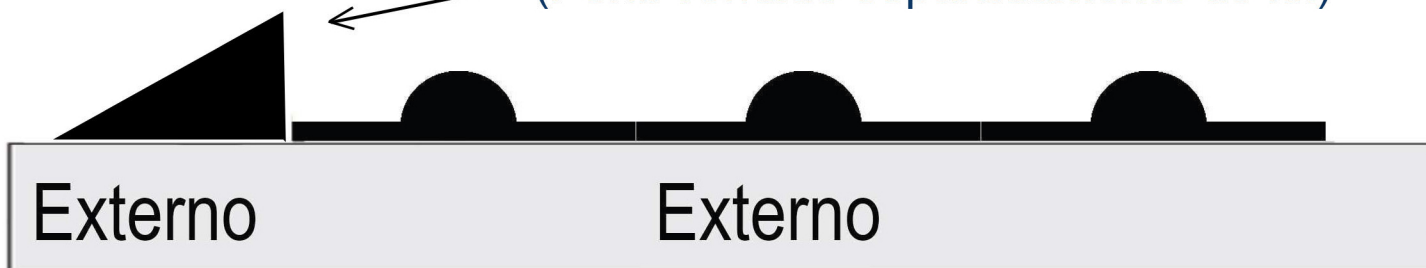

8- Fixar os trilhos superiores com parafusos e buchas, no prumo do trilho inferior.

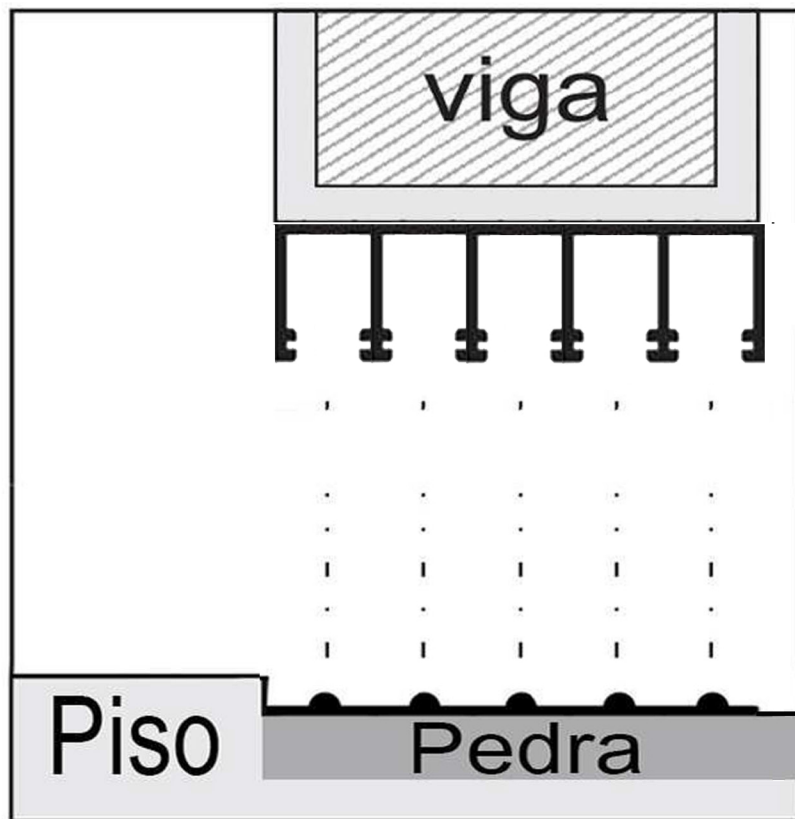



9- Colar a escovinha colante na borda inferior do vidro.

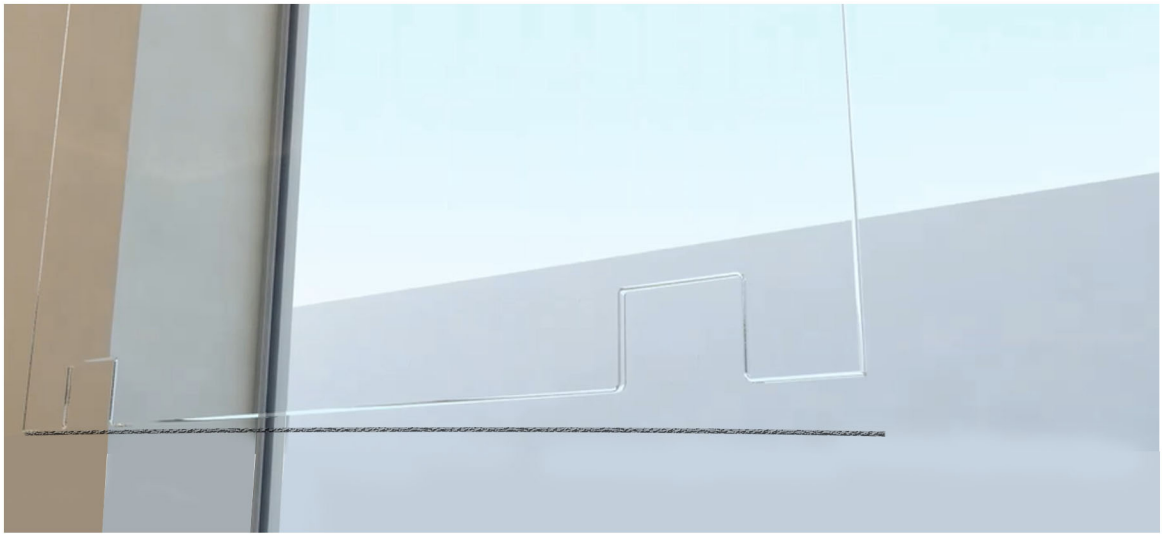

10- Cortar a escovinha e virar para dentro do recorte.



11- Colocar as roldanas no vidro 10 mm rente a borda inferior.



## Alinhamento dos vidros

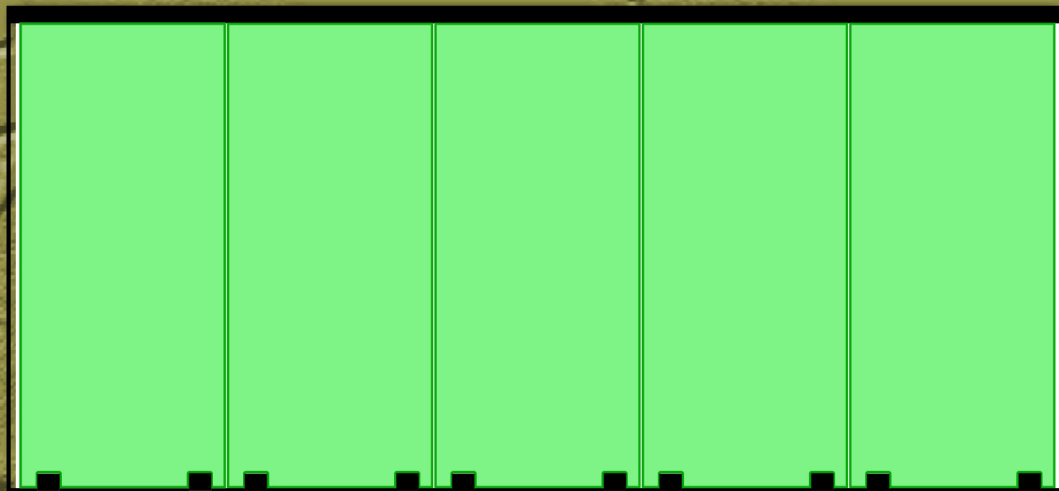

- 1 - Alinhe os vidros de forma que fiquem no prumo e no esquadro lado a lado
- 2 - Regule a altura da roldana e aperte bem a diferença do prumo é tirado nos ferfis laterais



12- Colocar as folhas de vidros nos trilhos, já com as roldanas instaladas.



13- Encaixar primeiro a parte superior e depois a parte inferior.



14- com os vidros instalados, corte o transpasso a 2 mm do trilho superior e a 3 mm da roldana, conforme a figura abaixo

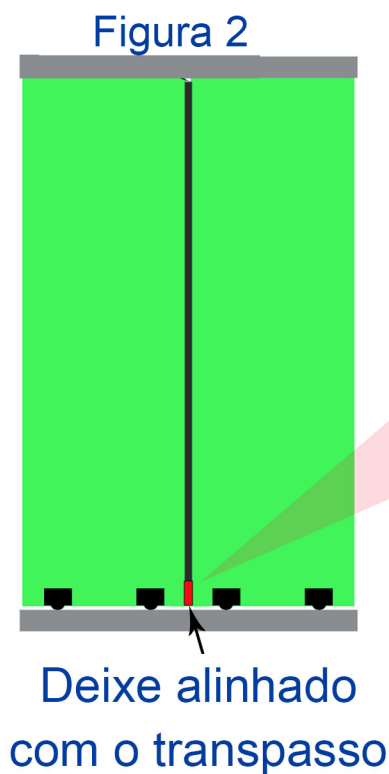
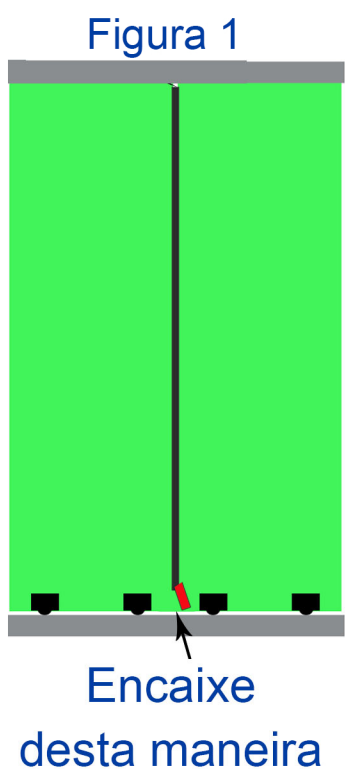
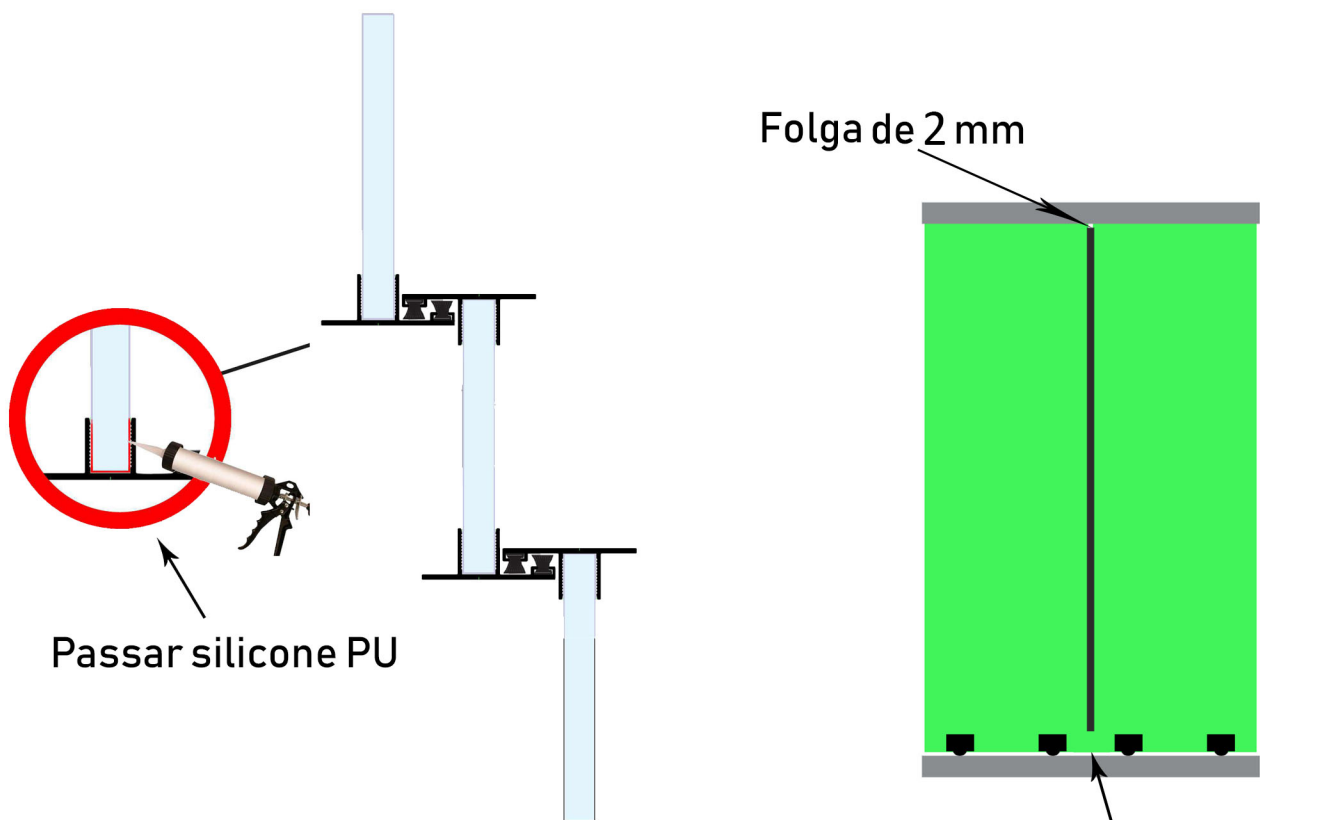

Acabamento do perfil



Depois do Transpasso instalado cole a peça de acabamento de acordo com a figura 1,2

## 18- Instalação contra fechadura

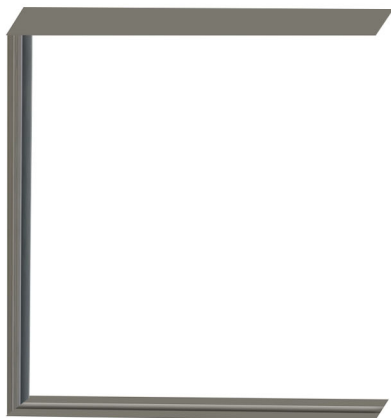

Cortar o perfil lateral rente ao trilho superior e inferior, fixar com parafuso e bucha na alvenaria

Encaixar a contra fechadura no perfil lateral



Ajustar a contra fechadura de acordo com a fechadura e apertar os parafusos.



Visite nosso site e utilize nosso aplicativo,  
é gratis, simples e fácil.



Em poucos segundos vc terá o projeto dos vidros,  
com recorte e furações.

