

G-21/10/2019

Gabarito
Especificações
técnicas
Slide windows
8 e 6 mm



Slide
WINDOWS®

 Reflexo de tecnologia,
qualidade e conforto.



Especificação Técnica

Slide Door Leaves 10 mm.

- Largura máxima por folha 1400mm, altura máxima por folha 3500mm
- Peso máximo 160kg por folha.
- Obs: Se a folha ultrapassar a largura de 1400 mm, adicionar mais uma roldana.

Slide Door Light 8 mm.

- Largura máxima por folha 1300mm, altura máxima por folha 2200mm
- Peso máximo 130kg por folha.
- Obs: Se a folha ultrapassar a largura de 1300 mm, adicionar mais uma roldana.

Slide Door Windows 8 e 6 mm.

- Largura máxima por folha 1000mm, altura máxima por folha 1800mm
- Peso máximo 75 kg por folha.
- Obs: Se a folha ultrapassar a largura de 1000 mm, adicionar mais uma roldana.
- Existem duas versões de kit, com bate e fecha e com fechadura verifique com seu vendedor diferença de valores e furação.

Garantia da Roldana é de 1 (um) ano por defeito de fabricação



Visite nosso site e utilize nosso aplicativo,
é gratis, simples e fácil.

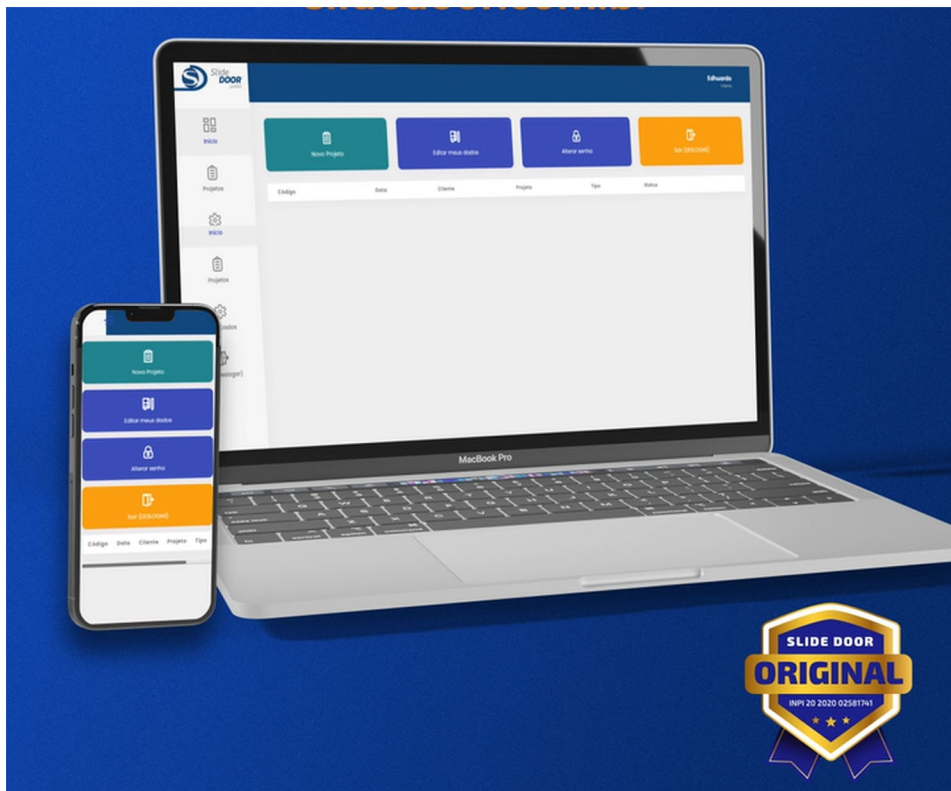

Em poucos segundos vc terá o projeto dos vidros,
com recorte e furações.

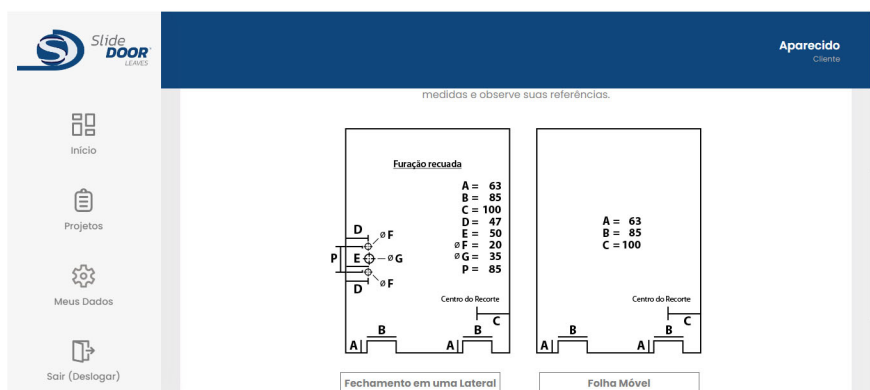

TRILHO INFERIOR

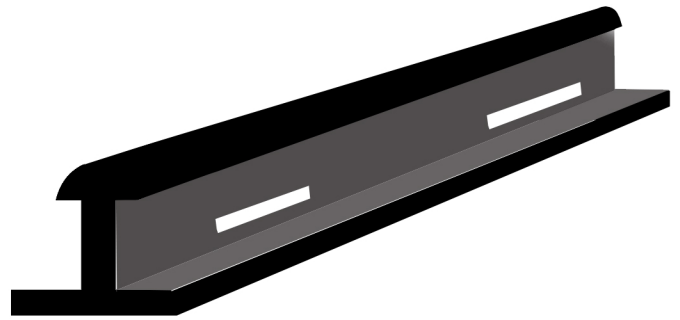
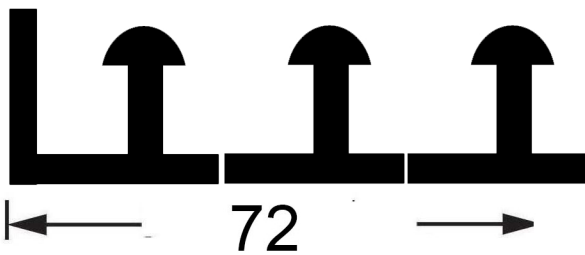
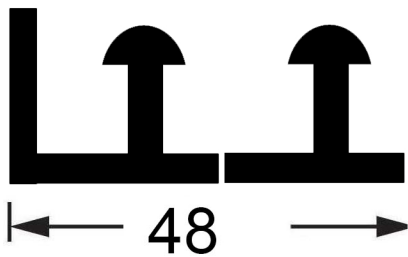
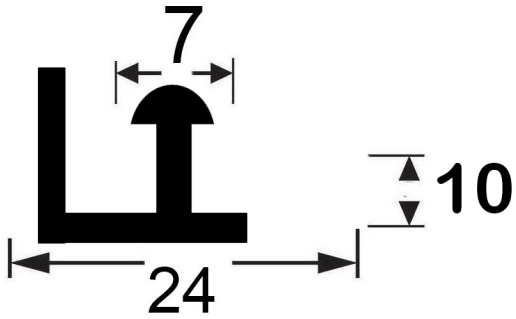

Com furação
de saída de água



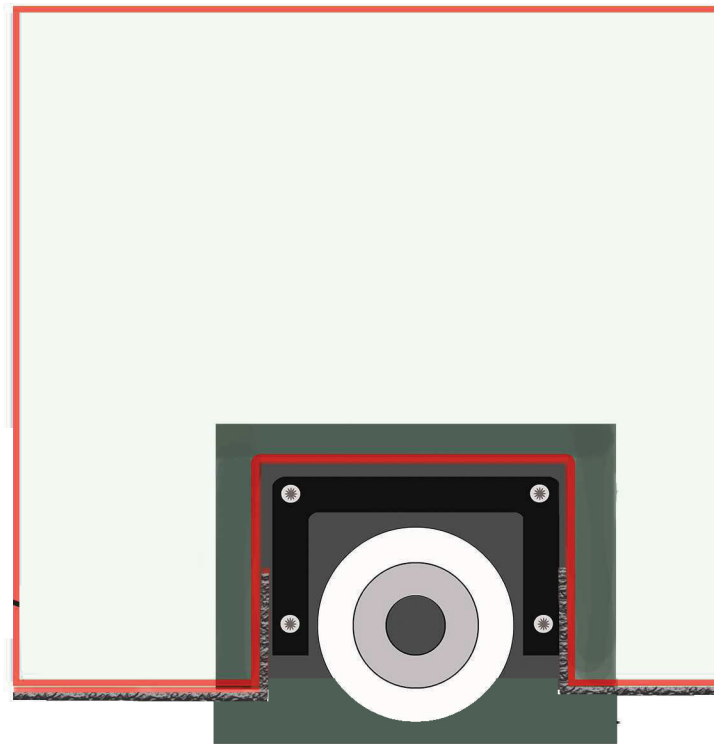
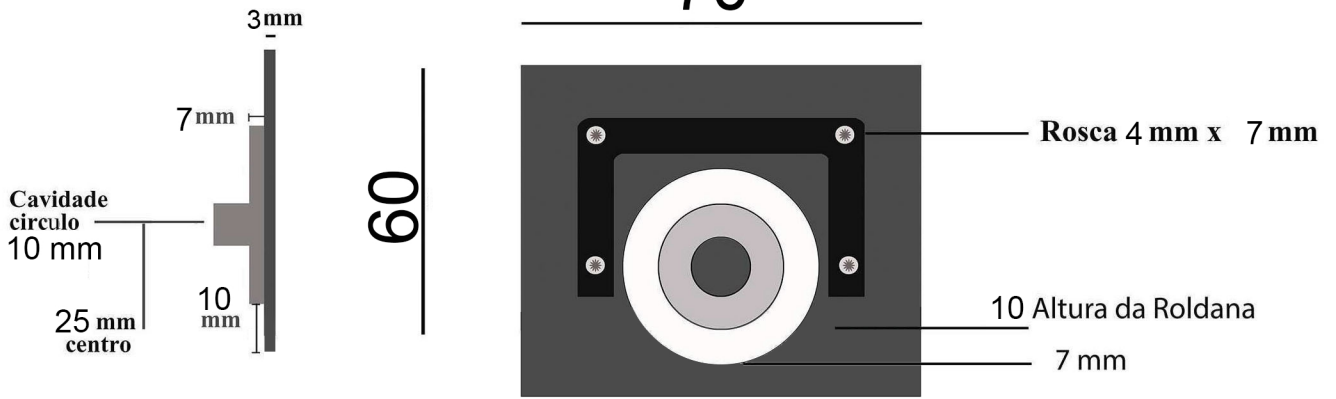

Colar escovinha na borda inferior do vidro





Slide
WINDOWS®

TRANSPASSE

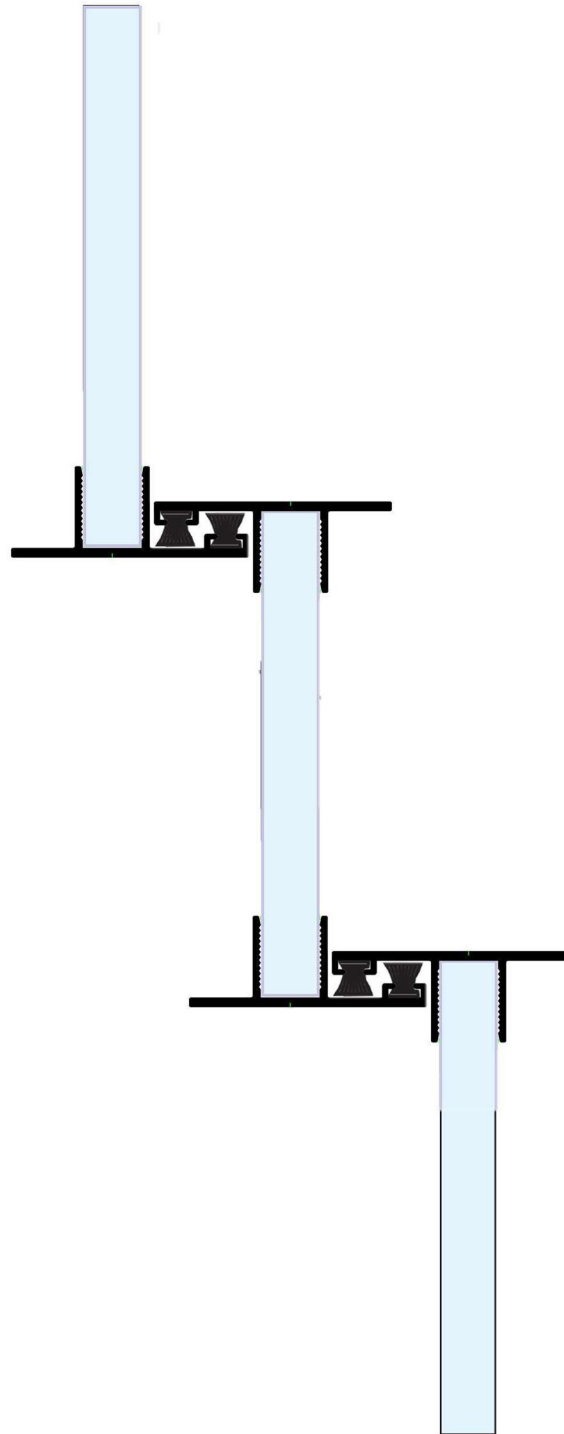
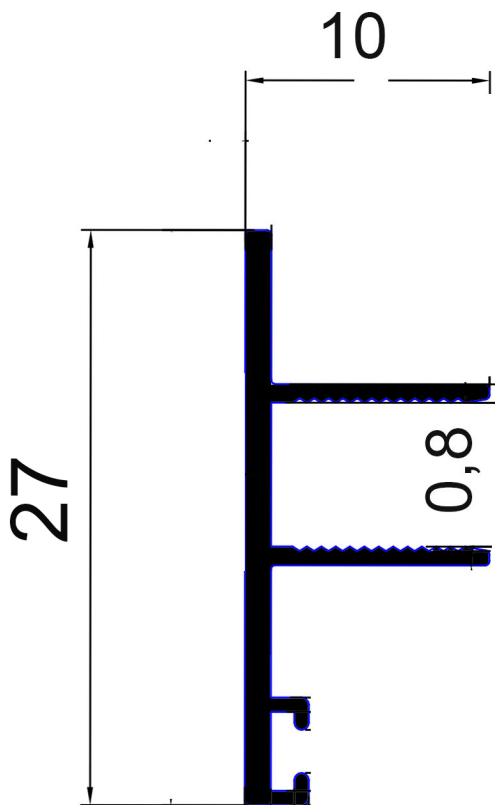



Fechadura



Contra v/v



Contra v/a

Bate Fecha



Contra v/v



Perfil U de encaixe



Perffil contra bate fecha





Slide
WINDOWS®

TRILHO SUPERIOR

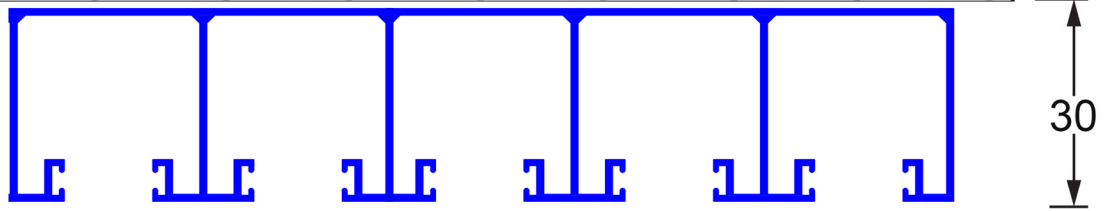
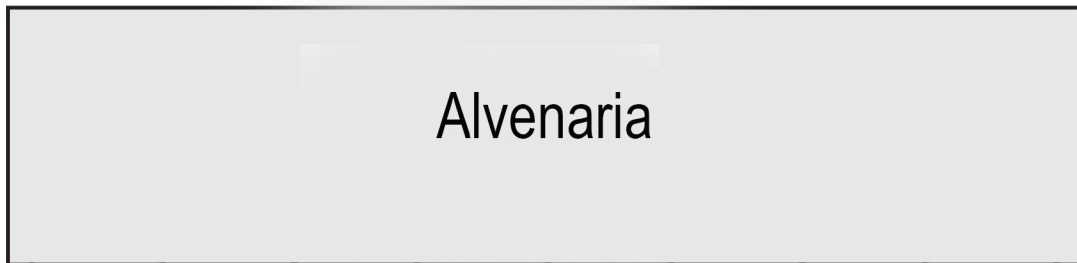
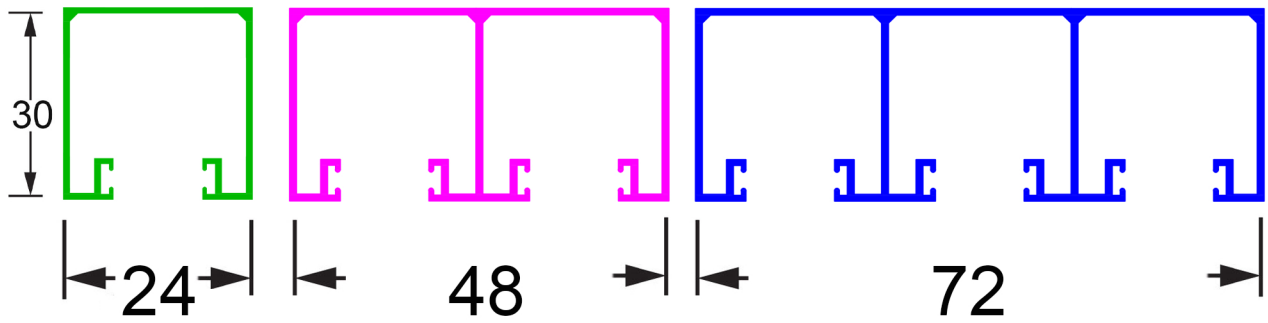



Slide
WINDOWS®

GABARITO

FURAÇÃO RECUADA PARA V-A

Recorte e Furação
Folha com Fechadura V/A

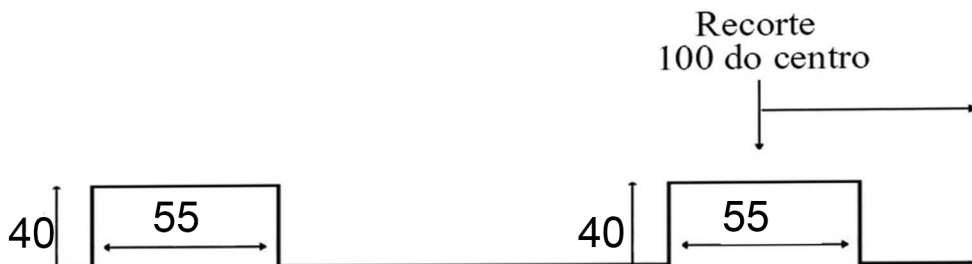
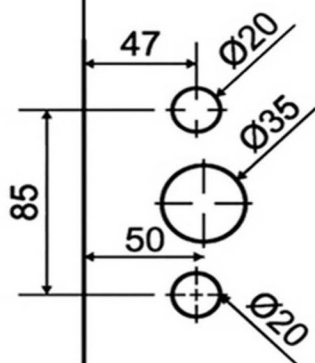



Slide
WINDOWS®

GABARITO

Folha(s) Móveis com Fechadura central v/v

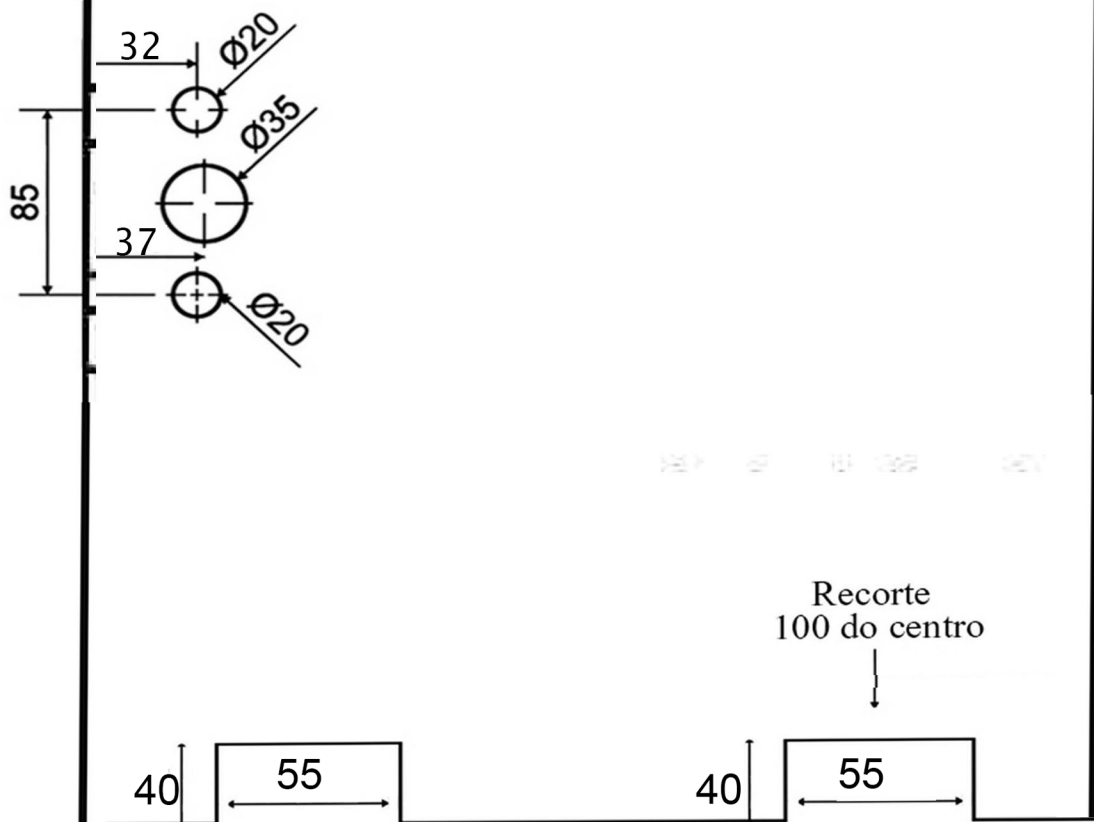



GABARITO

FURAÇÃO RECUADA PARA V-A

Recorte e Furação Folha com Fechadura V/A

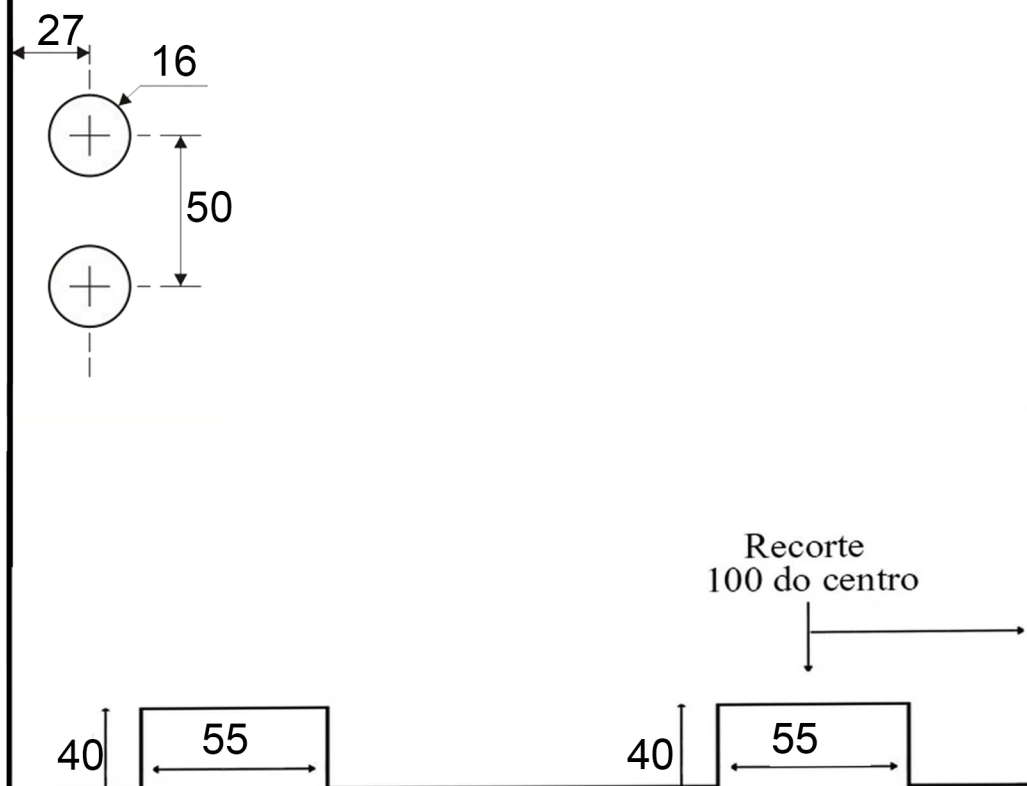



GABARITO

FURAÇÃO RECUADA PARA V-A

Recorte e Furação Folha com Fechadura V/ V

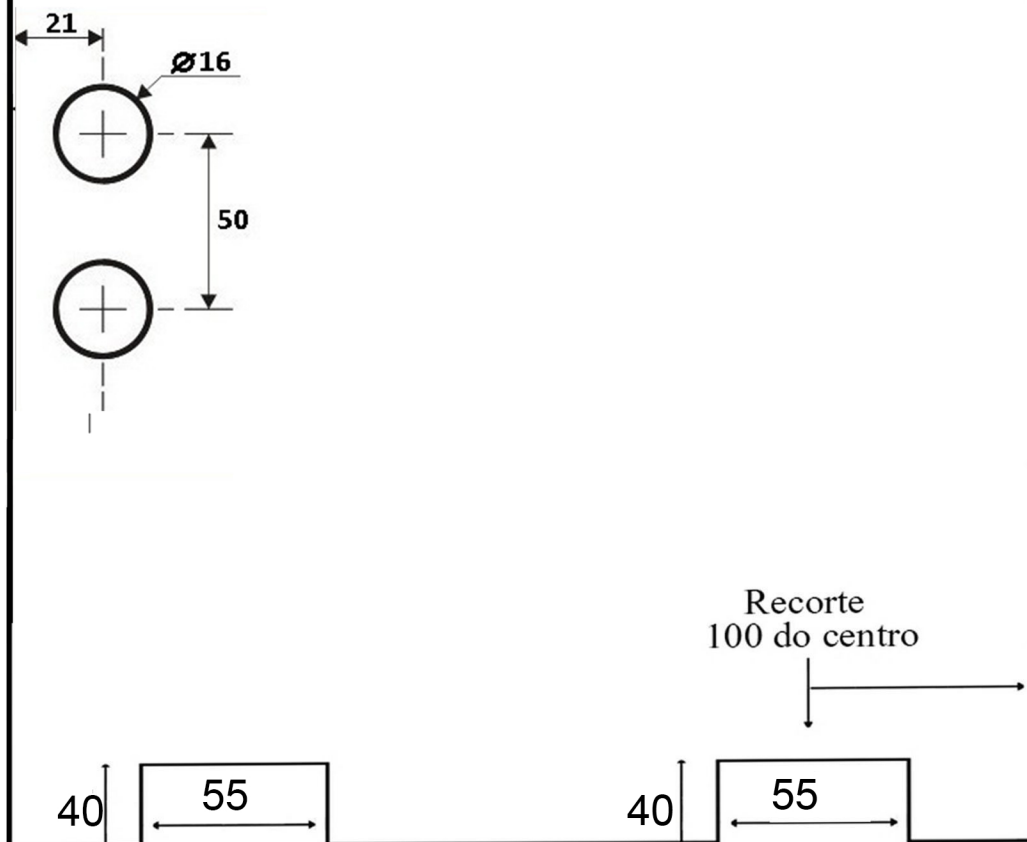



GABARITO

Recorte em mm
Folhas centrais de correr

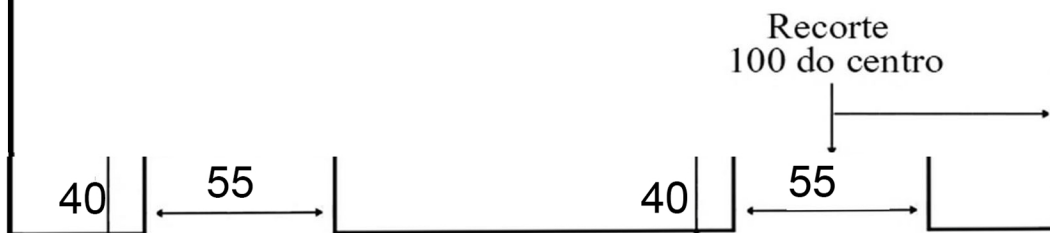

DIVISÃO DE VIDROS ABERTURA V/A

Altura, do vão descontar 40 mm
nas folhas moveis

Altura, do vão descontar 20mm
na folha fixa

Obs. Se for bate e fecha verificar furação no manual

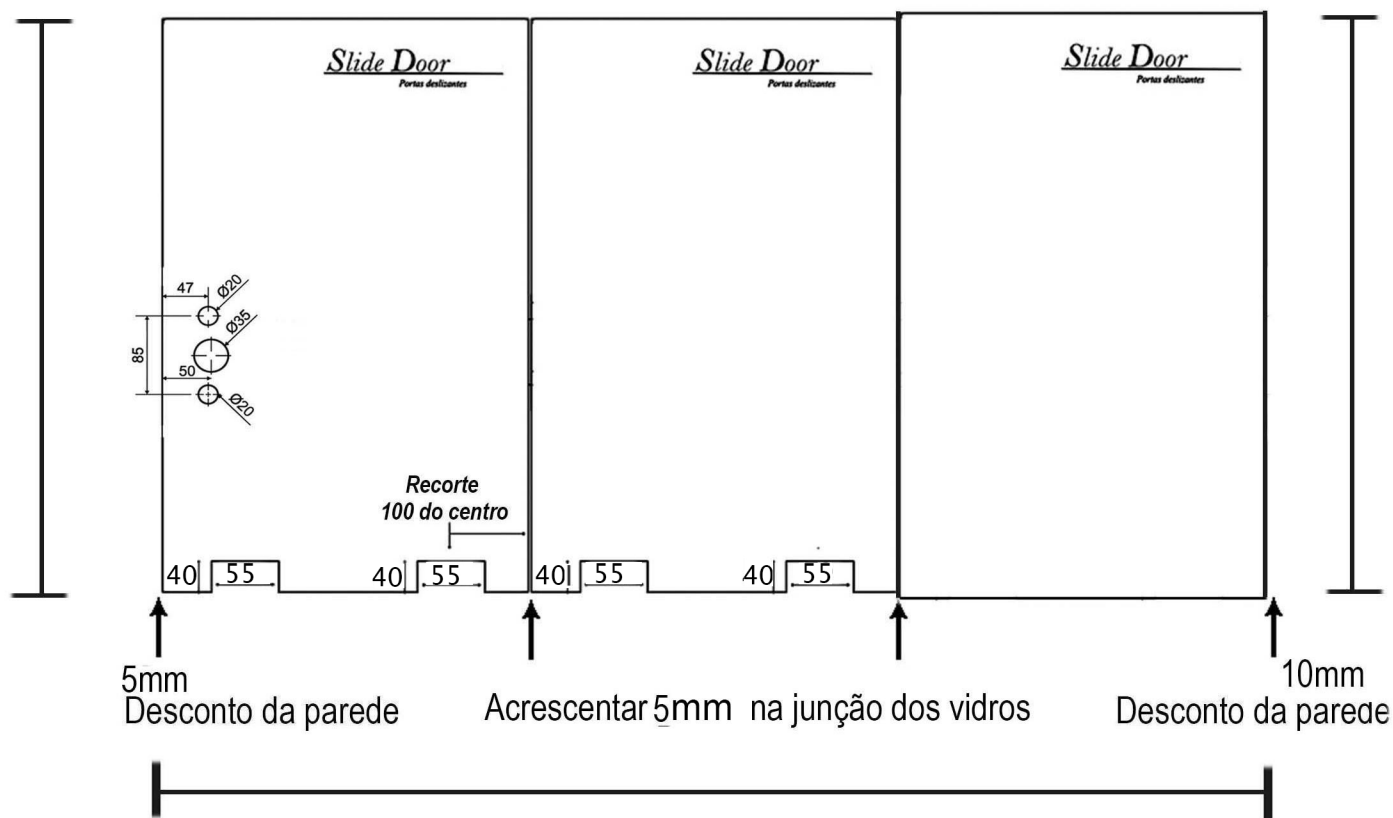

Largura do vão:

- 1- Descontar 5 mm do lado da fechadura e 10mm do lado do fixo
- 2- Acrescentar 5 mm cada junção de vidro
- 3- No resultado da medida, diminuir 100 mm se for só com fechadura ou 160 mm caso tenha puxador
- 4- Dividir o resultado no total de número de folhas, esta será a medida de cada largura das folhas, sem fechadura e fixos.
- 5- Acrescentar em cada folha móvel com fechadura 100 mm

Esta operação é para que a fechadura ou o bate fecha não bata no transpasse na hora da abertura

Altura do vão:

Descontar 20mm no fixo e 40mm nos móveis.



Altura, do vão descontar 40 mm

Obs. Se for bate e fecha verificar furação no manual

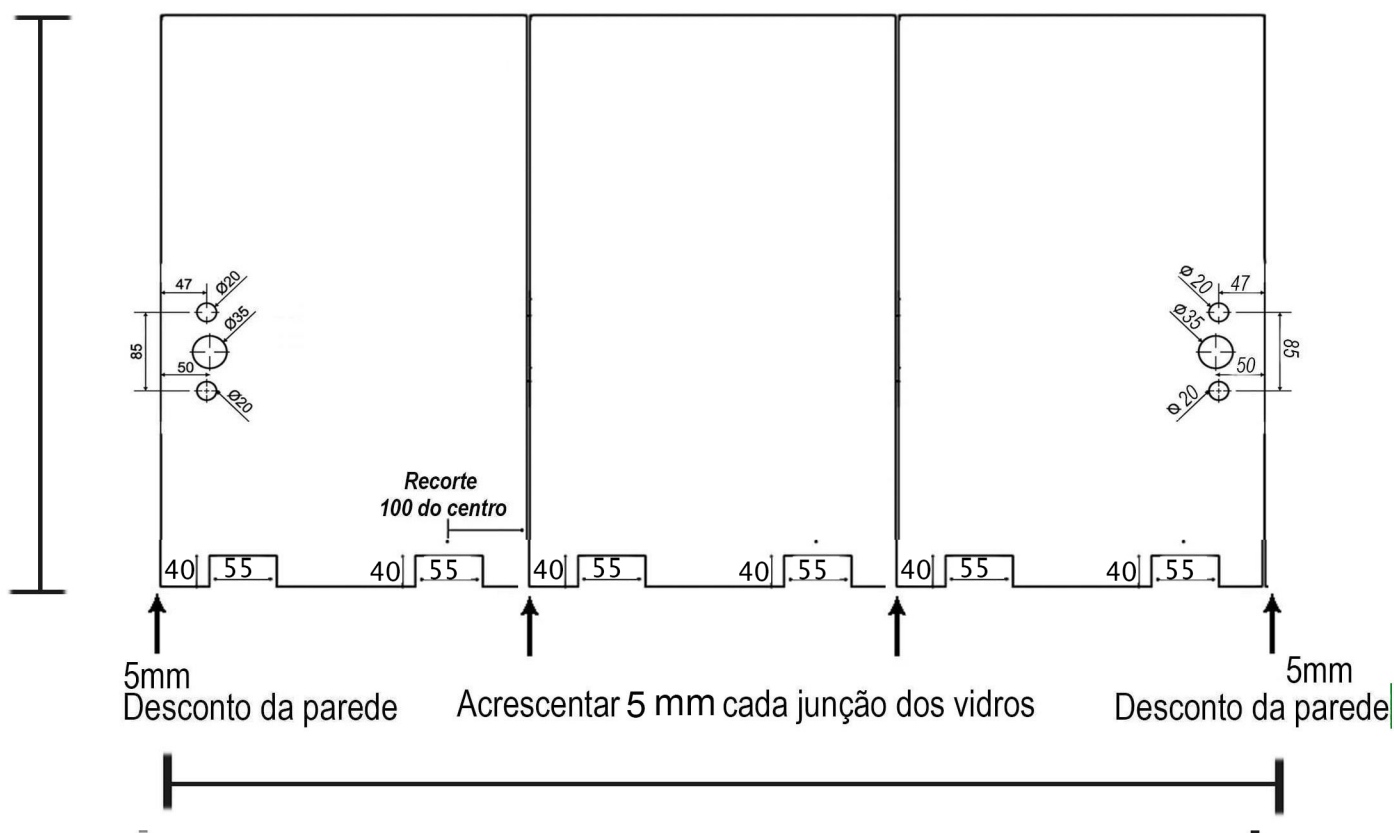

Largura do vão:

- 1- Descontar 5 mm do lado da fechadura e 10mm do lado do fixo
- 2- Acrescentar 5 mm cada junção de vidro
- 3- No resultado da medida, diminuir 100 mm se for só com fechadura ou 160 mm caso tenha puxador
- 4- Dividir o resultado no total de número de folhas, esta será a medida de cada largura das folhas, sem fechadura e fixos.
- 5- Acrescentar em cada folha móvel com fechadura 100 mm

Esta operação é para que a fechadura ou o bate fecha não bata no transpasse na hora da abertura

Altura do vão:

Descontar 20mm no fixo e 40mm nos móveis.



Altura, do vão descontar 40 mm
nas folhas moveis 40

Altura, do vão descontar 20mm
na folha fixa

Obs. Se for bate e fecha verificar furação no manual

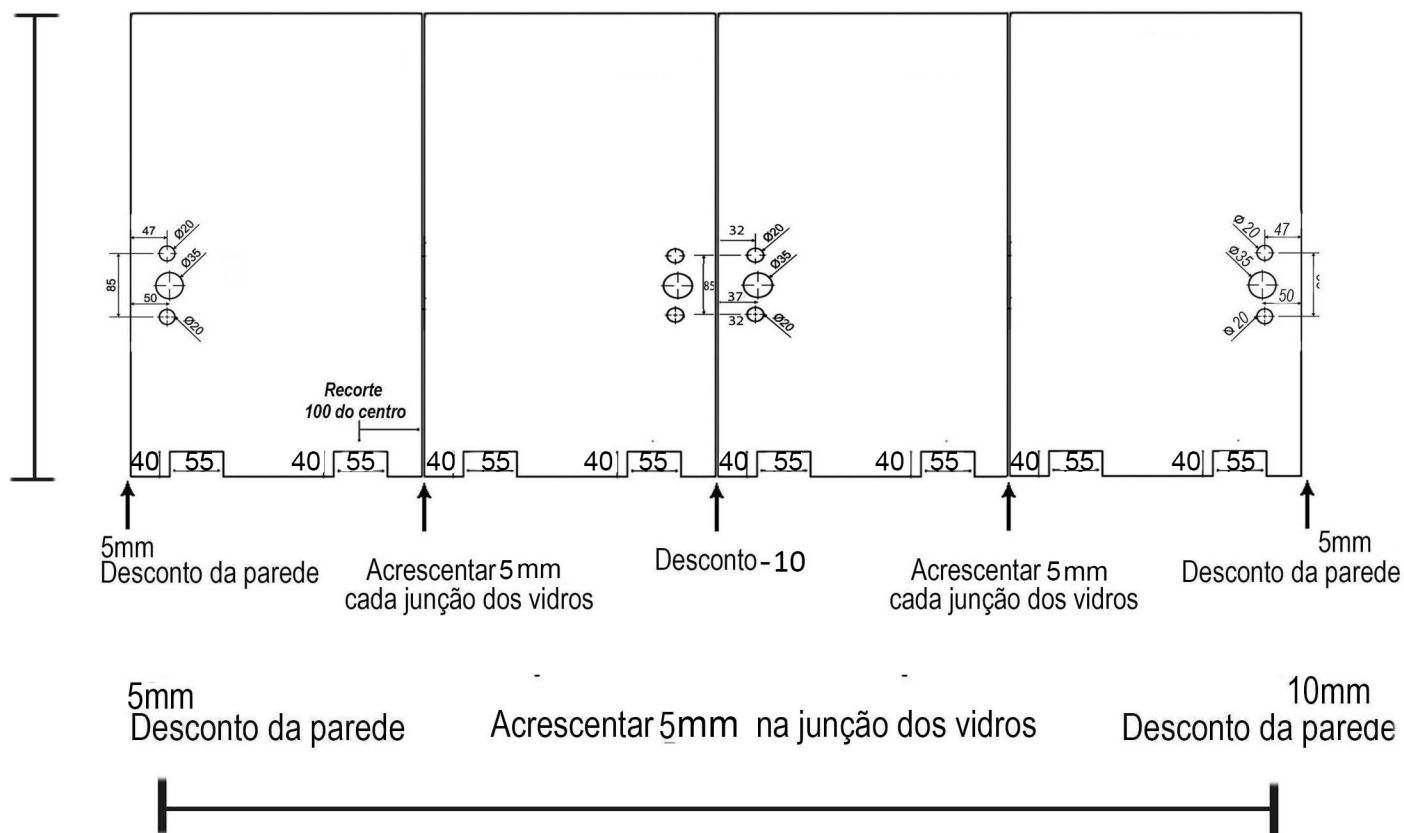

Largura do vão:

- 1- Descontar 5 mm do lado da fechadura e 10mm do lado do fixo
- 2- Acrescentar 5 mm cada junção de vidro
- 3- No resultado da medida, diminuir 100 mm se for só com fechadura ou 160 mm caso tenha puxador
- 4- Dividir o resultado no total de número de folhas, esta será a medida de cada largura das folhas, sem fechadura e fixos.
- 5- Acrescentar em cada folha móvel com fechadura 100 mm

Esta operação é para que a fechadura ou o bate fecha não bata no transpasse na hora da abertura

Altura do vão:

Descontar 20mm no fixo e 40mm nos móveis.



INSTALAÇÃO PASSO A PASSO

Pegar a menor medida do vão dentro do esquadro,
conforme a figura 1 e 2

1- Medir a menor altura do vão

Prumo do Vão —

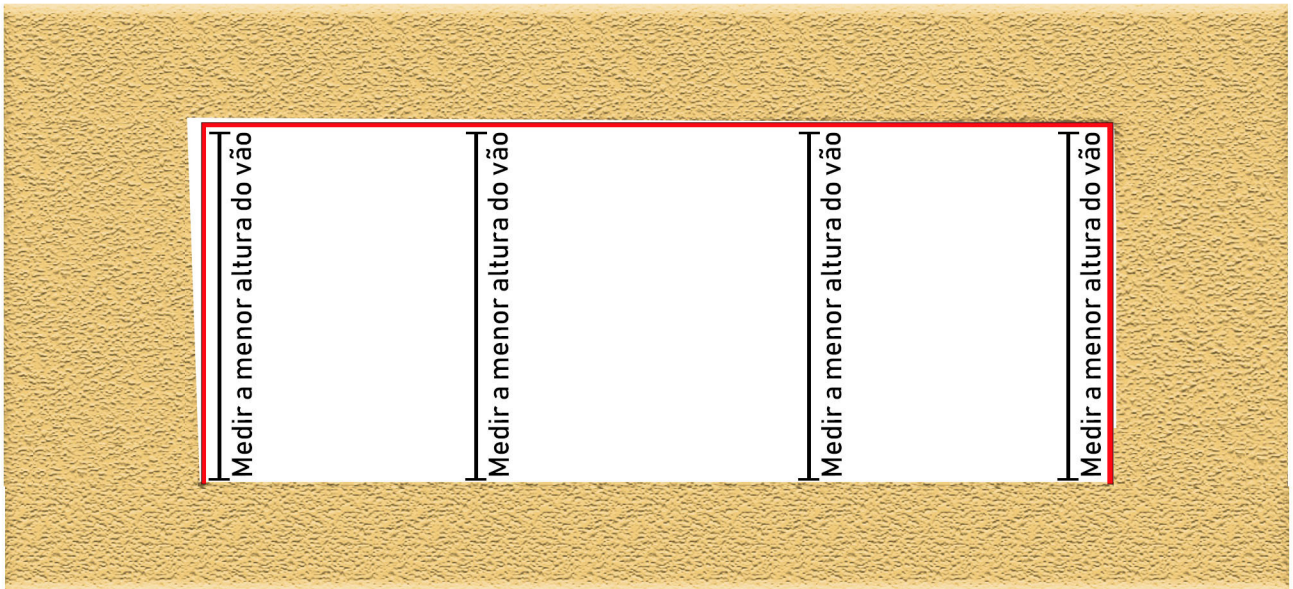

2- Medir a menor largura do vão

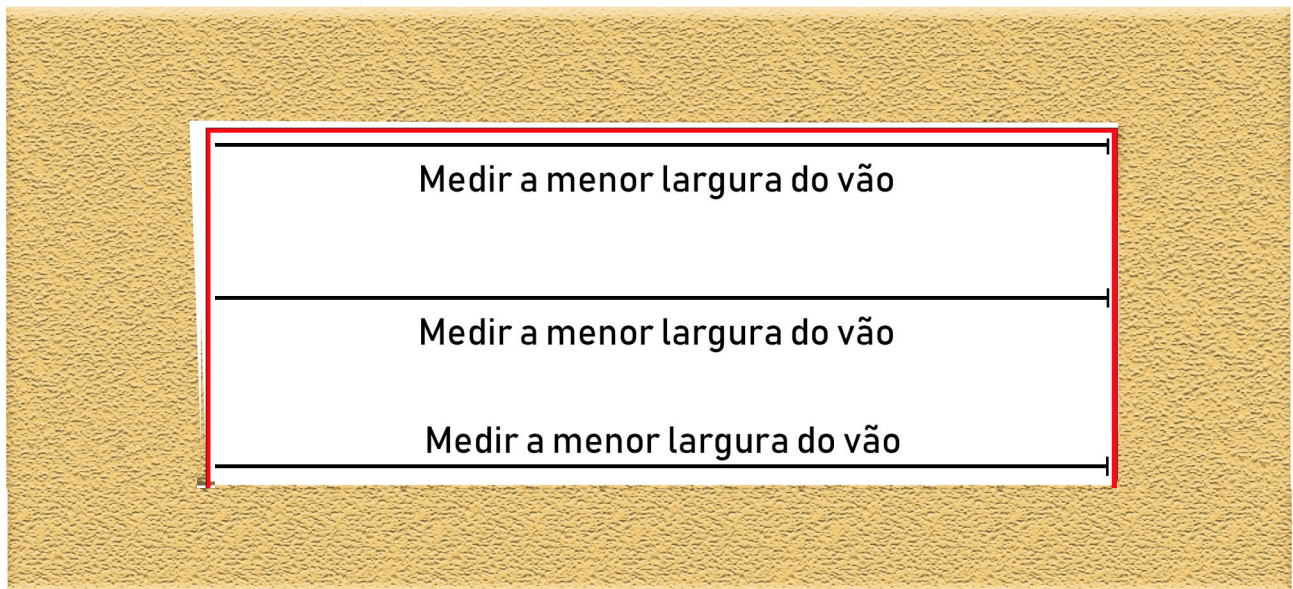

Praticar a menor medida dentro do esquadro

Obs: Colar com silicone PU indicado pelo fabricante

Colar os trilhos um de cada vez, um ao lado do outro, encostando as laterais e unindo para ficar uniforme, conforme as fotos ilustrativas.

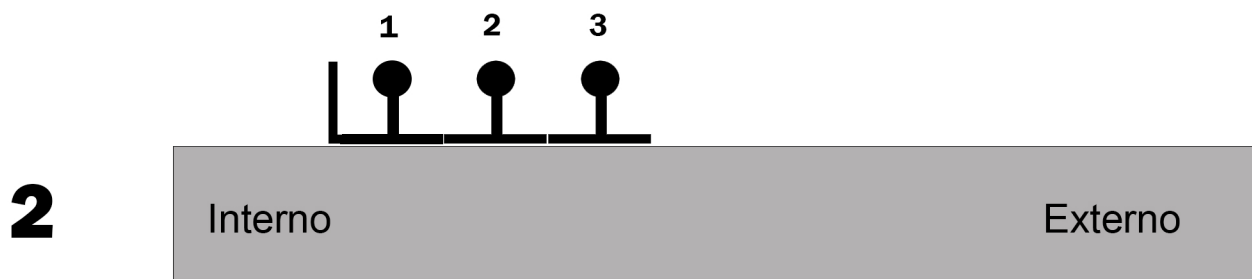
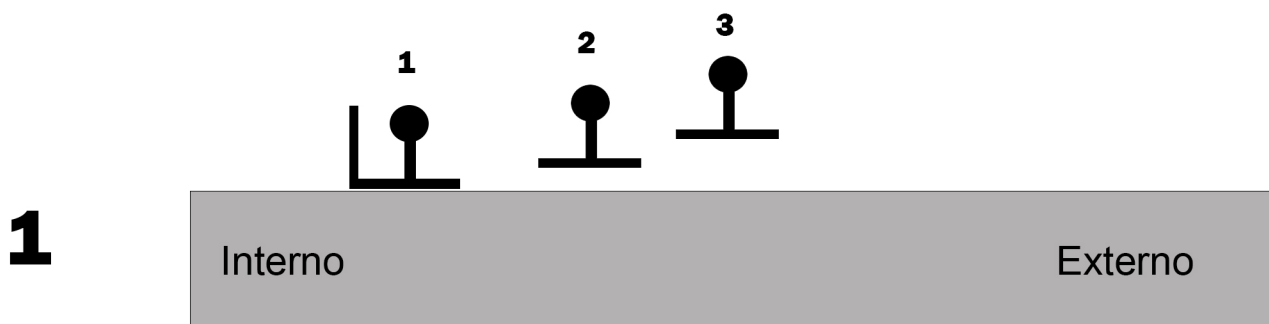

Quando for colocar vidro fixo, colocar perfil - U

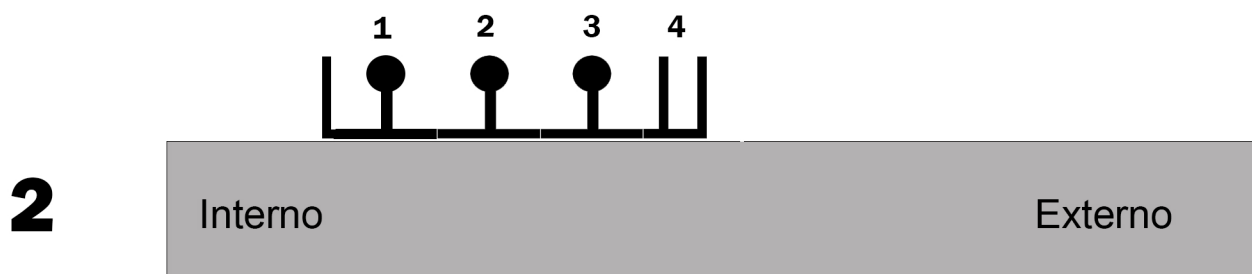
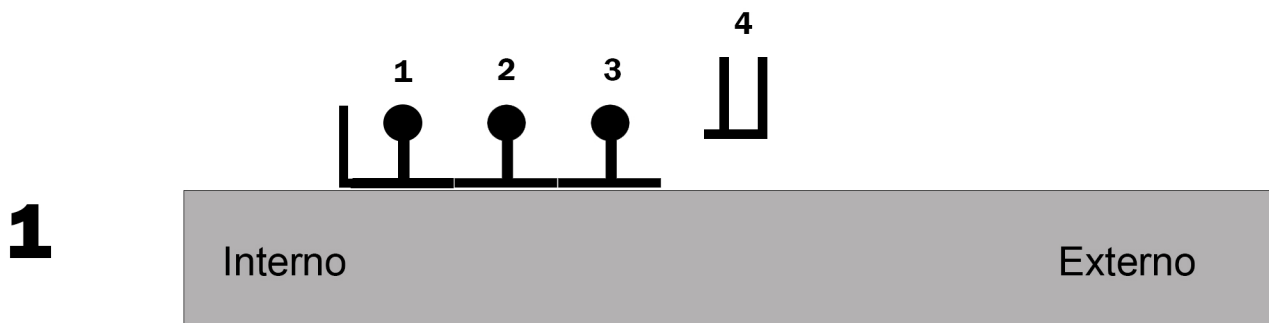

8- Fixar os trilhos superiores com parafusos e buchas, no prumo do trilho inferior.



Instalação abertura sem fixo

Instalação abertura com fixo

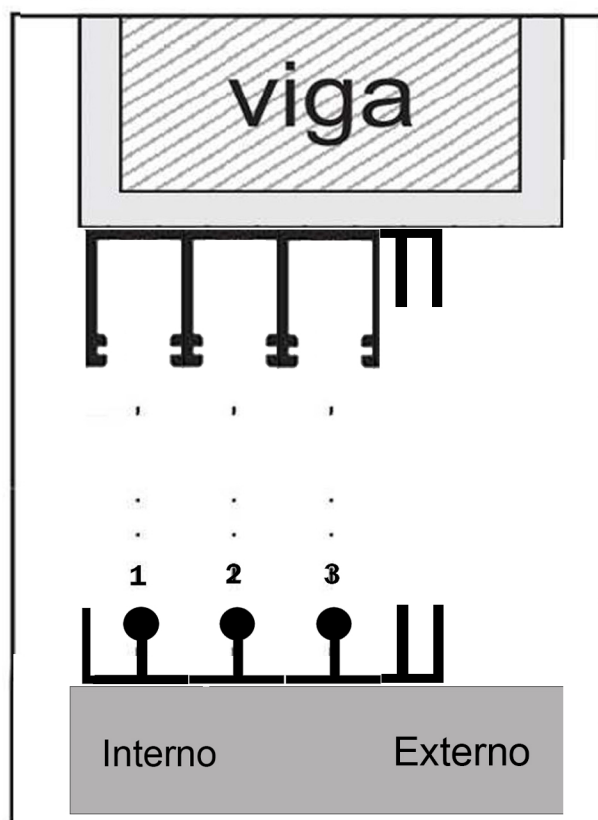
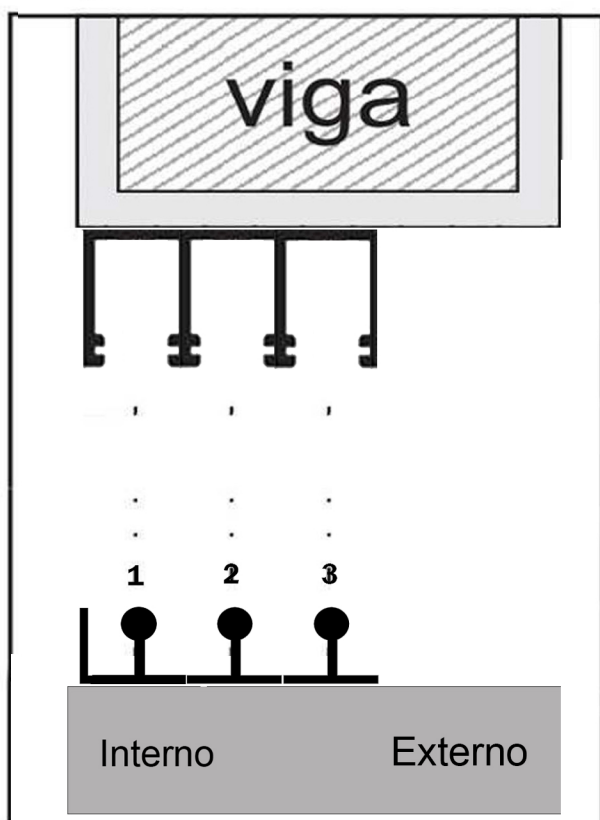

9- Colar a escovinha colante na borda inferior do vidro.

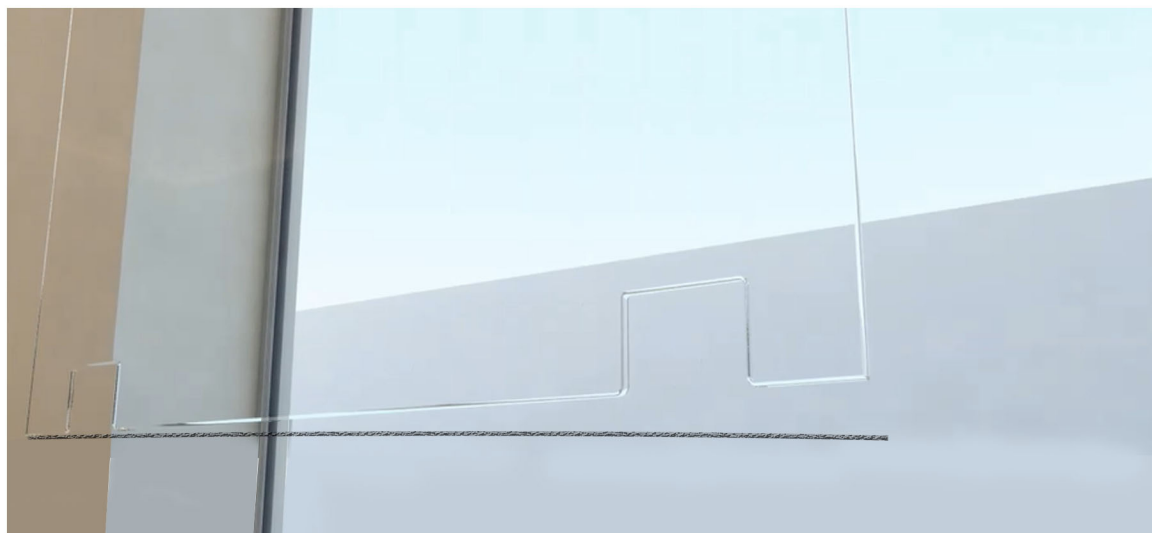

10- Cortar a escovinha e virar para dentro do recorte.

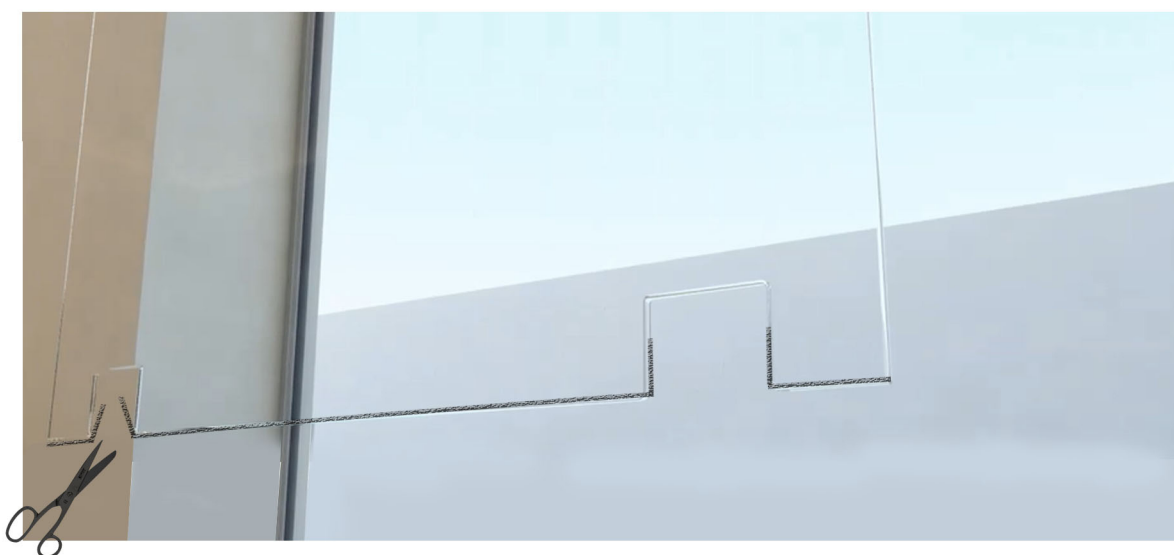

11- Colocar as roldanas no vidro 10 mm rente a borda inferior.



Parear a roldana na
borda do vidro

Depois de instalar o vidros, ajuste as roldanas deixando 2 mm do final do trilho.



Alinhe os vidros no prumo independente do plumo do vão

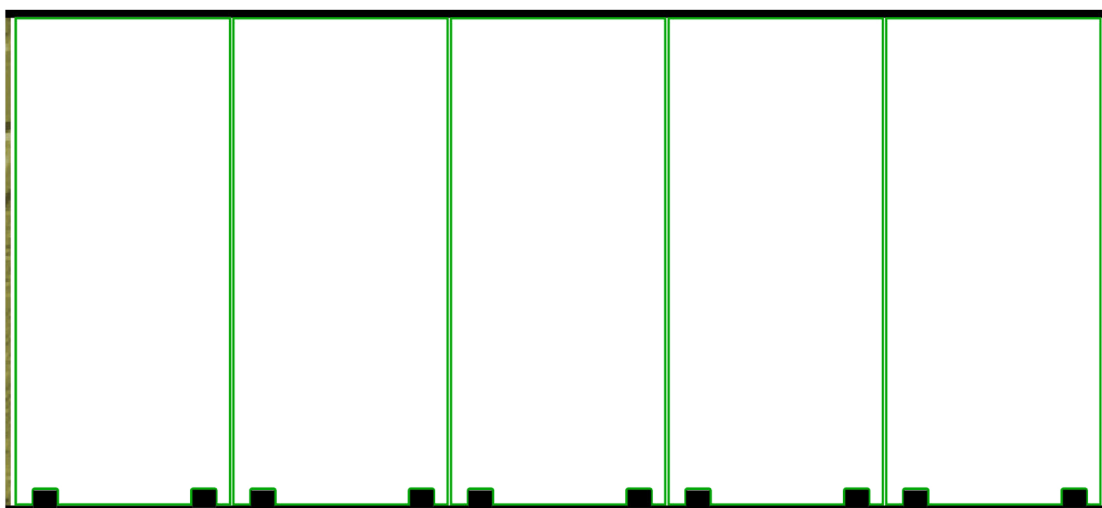

A diferença do prumo ficará nas laterais, posteriormente regulado com a bate fecha ou fechadura.

Em caso de vidro fixo a diferença é regulado no vidro fixo.

14- com os vidros instalados, corte o transpasso a 2 mm do trilho superior e a 3 mm da roldana, conforme a figura abaixo

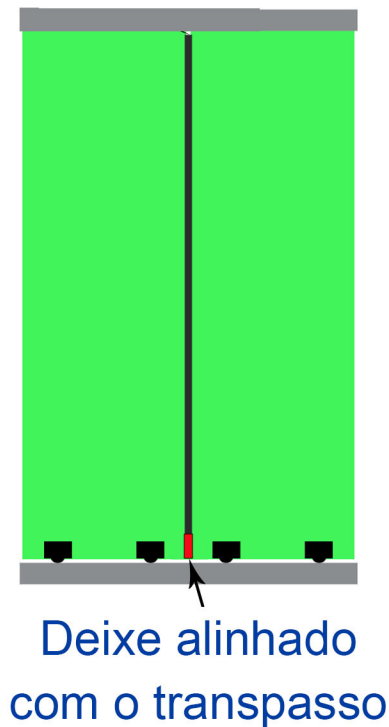
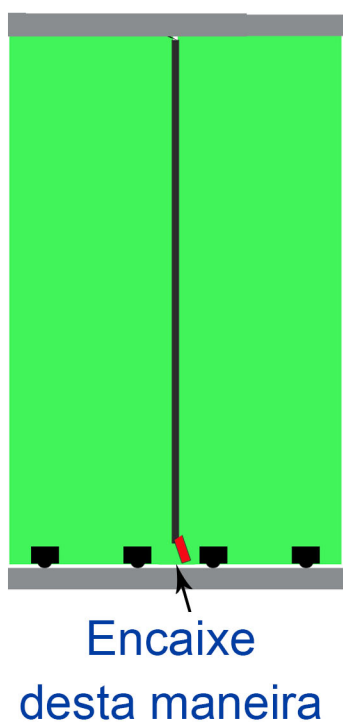
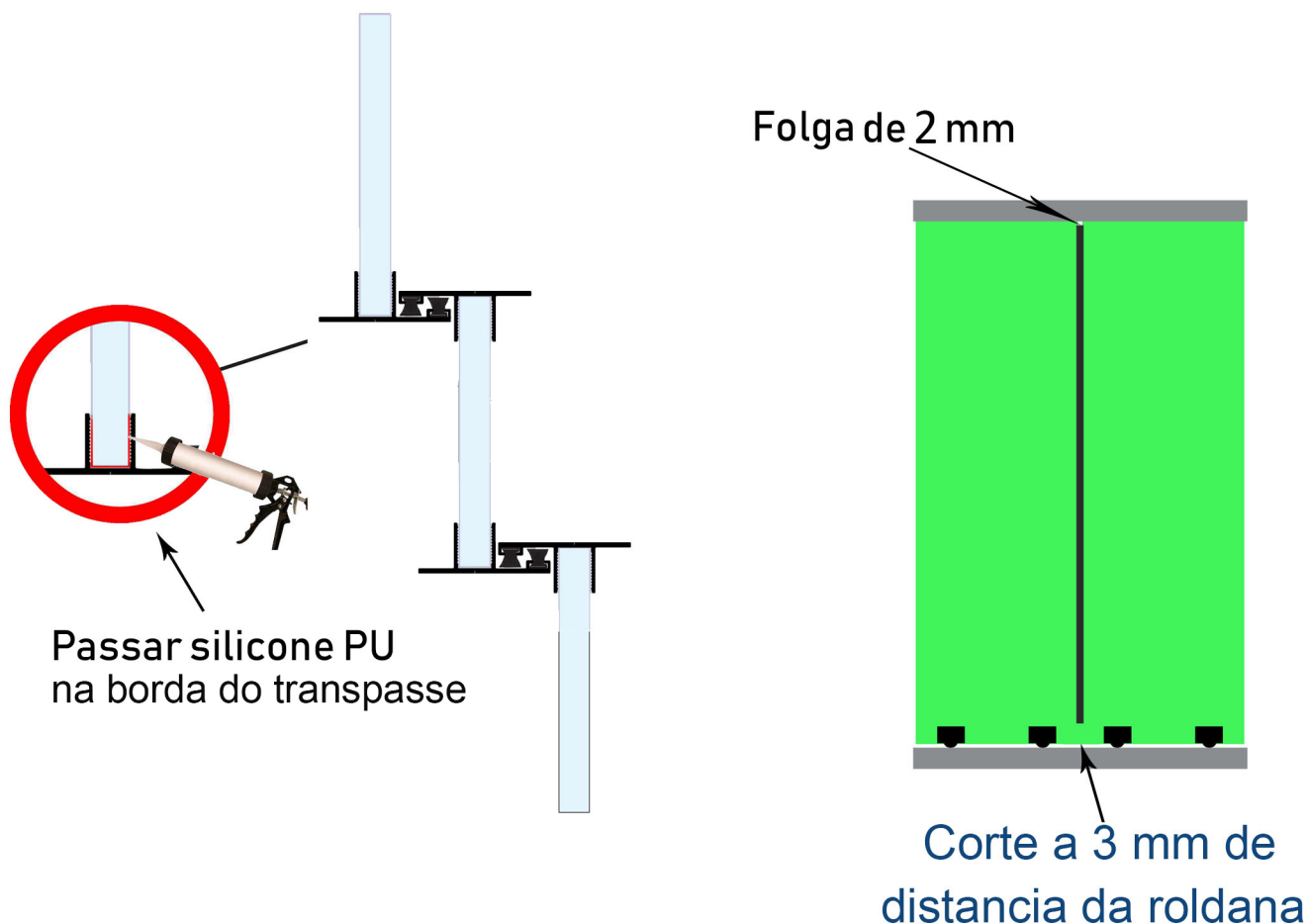

Instale o perfil contra bate fecha com bucha e parafuso;

Aconselhamos aplicar silicone PU para melhor fixação



Instale a bate fecha no vidro
Regule conforme no prumo



18- Instalação contra fechadura

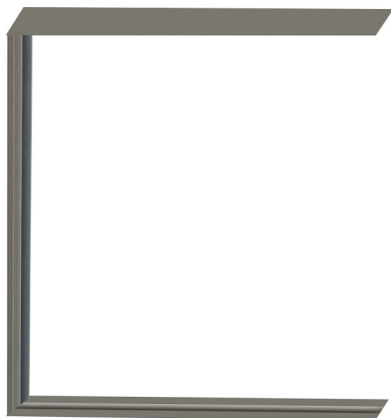

Cortar o perfil lateral rente ao trilho superior e inferior, fixar com parafuso e bucha na alvenaria

Encaixar a contra fechadura no perfil lateral



Ajustar a contra fechadura de acordo com a fechadura e apertar os parafusos.



Visite nosso site e utilize nosso aplicativo,
é gratis,simples e fácil.

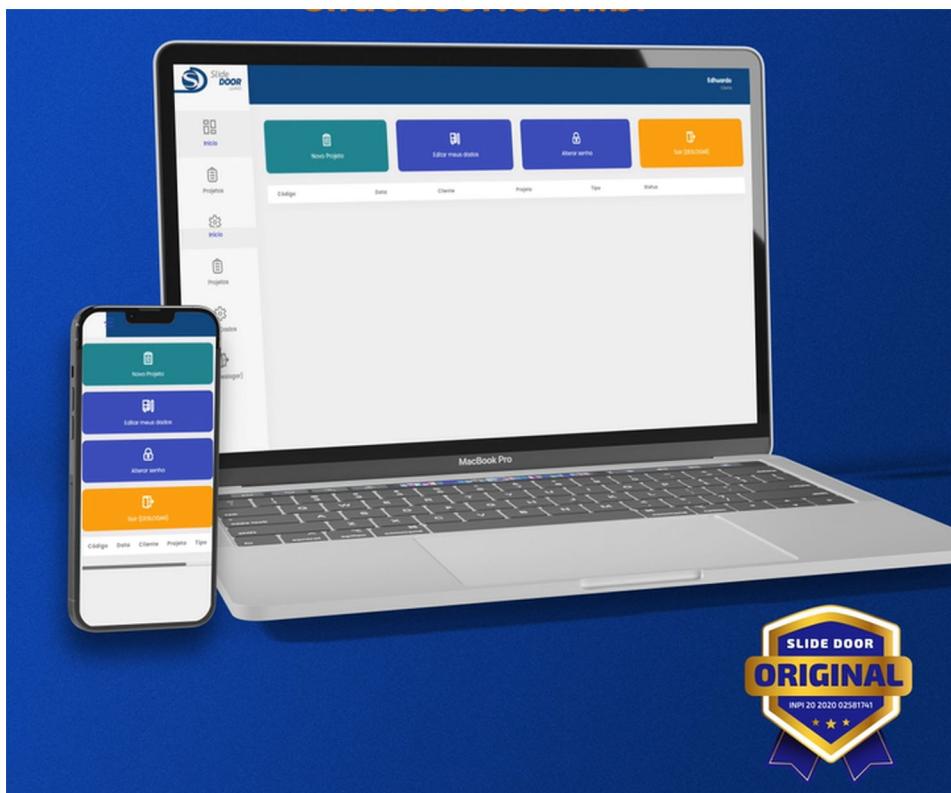

Em poucos segundos vc terá o projeto dos vidros,
com recorte e furações.

